

# Acoustic Pods



## Space 1.5

Spacious acoustic room for 1 person.

### A PEACEFUL RETREAT FOR SOLO WORK

**S1.5** acoustic pod brings **extra room** for uninterrupted work sessions. With optional **height-adjustable desk add-on**, it creates a flexible **island of silence** for work in louder **open office** concepts.

**Space 1.5** private booth is multifunctional, movable, and just like other Space pods, it **brings privacy** and a **relief from office noise** and **distractions**. S1.5 works as a comfortable **workstation, phone booth, or video conferencing pod** for one person.

\* Furniture not included

## Flexible Setups



Eden & Silver Grey exterior

### Phone Booth

Adaptable one-person soundproof space with an integrated table and freestanding 360° revolving chair.



Jade exterior

### Video Conference Pod

Video call room and phone booth with folding chair, ability to install your own screen and connect your devices.



Marshmallow exterior

### Flexible Workspace

Flexible configuration with height-adjustable table and lightweight stool for uninterrupted work sessions.



# Measurements

## Space 1.5

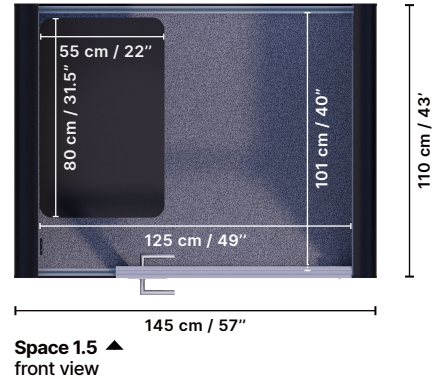
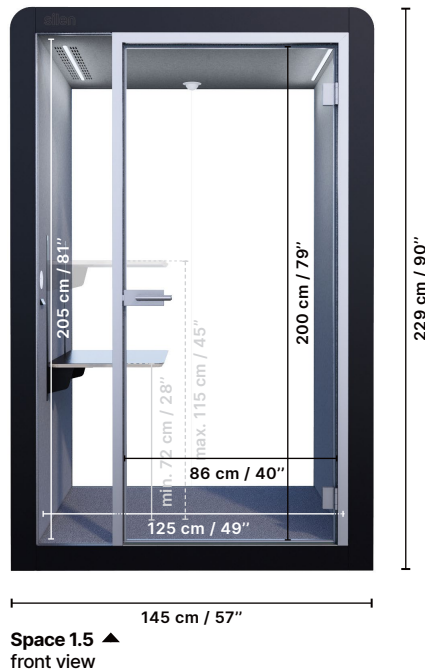

### Space 1.5 Phone Booth

Furnished with built-in height-adjustable table.

Interior floor area  
1.3 sqm / 13.6 sqft

## Specification

### Size

Exterior: W cm/in, H cm/in, D cm/in  
145/57 229/90 110/43

Interior: W cm/in, H cm/in, D cm/in  
125/49 205/81 101/40

### Weight

428 kg / 944 lb

### Door

Left or Right

### Lighting

LED light; 4000K (3000K per request)  
with motion sensor; energy-efficient

### Power connection

Through the floor or ceiling;  
plug to 15 Amp power outlet

### Additional pod features

- Automatic door operator and push-to-open buttons
- Silen Dynamics Generation: easily exchangeable side skins
- Quest fabric selection for exterior walls only

### Wall, Ceiling

EchoFree acoustic panels

### Floor

Antistatic, stain resistant carpet for public spaces

### Glass

6+6 mm acoustic laminated sound control glass

### Air ventilation

Low power consumption 6.8W air circulation system ( speed - 80l/s; full air exchange time ~32s)

### Casters

For easy relocation

### Adjustable legs

For leveling and stability

## Finish selections

### Profiles / Door frame



### Hinges / Door handle



### Interior colours

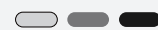

### Exterior colours

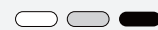

### Additional colours



### Veneer finishes



click to  
**Configure S1.5**

**ASTM E84**  
CLASS A

acoustics  
**41 STC**

**UL** LISTED  
US UL 962

**CERTIFIED**  
**CARBON**  
**NEUTRAL**  
product

**CERTIFIED**  
ENVIRONMENTALLY  
PREFERABLE PRODUCT  
GLOBAL SOURCE

**Available Add-ons  
for Space 1.5**



**Private Office Pod**

- **Height-adjustable table** (height: min 720mm, max 1150mm | table top: 800x550mm)
- **Task chair** (externally sourced)
- **Air flow and lighting dimmer**
- **Power socket 110V + USB charging ports**
- **Textile sides** (Quest fabric selection)

- **Bambus cover trims**
- **Bernacle textile sides**
- **Light Grey interior**
- **Black profiles**



**Lounge Phone Booth**

- **Fixed-height table** (height: 740mm/29" | table top: white; 800x550mm)
- **Power socket 110V + USB charging ports**
- **Vega low-back task sofa**
- **Occupancy indicator light**
- **Extra colour laminate**

- **Opal exterior**
- **Black interior**
- **White profiles**



**Video Conference Room**

- **Screen bracket + full V/C readiness**
- **Centered built-in table** (height: 1050mm/41")
- **Extra face lights** for improved video calls
- **Height-adjustable task chair** (externally sourced)
- **Air flow and lighting dimmer**
- **Power socket 110V + USB charging ports**
- **Extra colour laminate**

- **Myosotis exterior**
- **Dark Grey interior**
- **Grey/Aluminum profiles**



**Short work**



**Phonecalls**



**Virtual meetings**



# Get Inspired with Space 1.5



<sup>1</sup> V/C ready models, built-in tables + wall screen mounts



<sup>2</sup> Workstation with height-adjustable desk

scan for  
**Space 1.5 AR**



## Finish Selections

### Interior Colours

#### Standard wall and ceiling.

EchoFree acoustic paneling



Light Grey  
1893



Dark Grey  
1897



Black  
1961

#### Standard floor.

Desso Essence carpet



Light Grey  
9507



Dark Grey  
9502



Black  
9990

### Aluminum Profiles

#### Doors, glass profiles and inside connections.



White  
RAL 9003 profiles  
Grey anodized door fittings



Anodized Grey  
Grey anodized profiles



Black  
RAL 9005 profiles  
Black door fittings

### Door Hardware

#### Handle and hinges.



Anodized Grey  
Grey anodized door fittings



Black  
RAL 9005 profiles  
Black door fittings

### Exterior Colours

#### Standard exterior finishes.

HPL from Egger and Resopal



Snow White  
RAL 9003

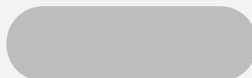

Silver Grey  
RAL 7035



Black  
RAL 9011

### Modular Sofa Colours

#### Standard fabric colours.

QUEST - Eco-friendly fabric from Camira.



Light Grey  
QUE 02

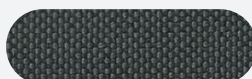

Dark Grey  
QUE 04

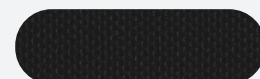

Black  
QUE 01

# Additional Finishes

## Exterior Colours

### Additional exterior finishes.

Laminate from Innovus



**Cotton**  
RAL 7044



**Basalt**  
RAL 7048



**Coal**  
RAL 7022



**Bambus**  
RAL 120 60 10



**Mint**  
RAL 6019



**Jade**  
RAL 6034



**Opal**  
RAL 2204015



**Eden**  
RAL 6005



**Citrus Green**  
RAL 100 80 60

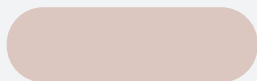

**Marshmallow**  
RAL 040 80 10



**Myosotis**  
RAL 4009



**Orange**  
RAL 2008



**Paprika**  
RAL 2013



**Mango**  
RAL 080 80 60



**Deer**  
RAL 1024



**Hot Pepper**  
RAL 3020



**Azurite**  
RAL 5008



**Blue Tiber**  
RAL 5003



**Storm Gray**  
RAL 240 50 05



**Frozen Blue**  
RAL 250 70 10

### Veneer finishes.

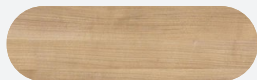

**Oak Veneer**  
R0015 - Planked



**Dark Oak Veneer**  
TH009 - Planked



## Additional Finishes

### Textile Colours (Modular Sofas & Pod Textile Sides)

Additional fabric colours.

QUEST - Eco-friendly fabric from Camira.



Depth  
QUE 01

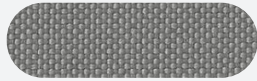

Fossil  
QUE 02

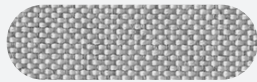

Bernacle  
QUE 03



Mussel  
QUE 04



Quartz  
QUE 05



Shell  
QUE 06



Ripple  
QUE 07

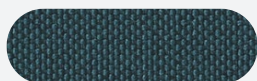

Whelk  
QUE 08

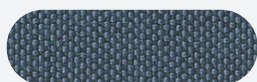

Limpet  
QUE 09

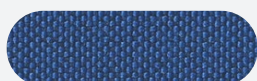

Rock Pool  
QUE 10

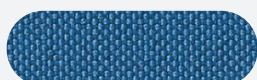

Wave  
QUE 11



Tide  
QUE 12

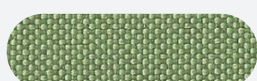

Sea Grass  
QUE 13

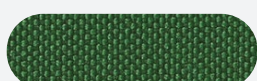

Algae  
QUE 14



Kelp  
QUE 15



Sea Foam  
QUE 16



Urchin  
QUE 17

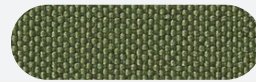

Abalone  
QUE 18



Driftwood  
QUE 19



Sandstone  
QUE 20



Beach Comber  
QUE 21



Salt  
QUE 22

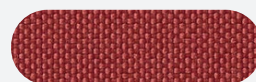

Cockle  
QUE 23

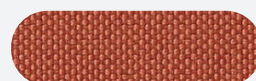

Crab  
QUE 24

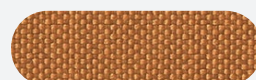

Clay  
QUE 25

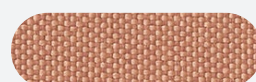

Shrimp  
QUE 26

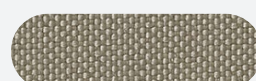

Pebble  
QUE 27

# Best Features & High-End Materials

silen

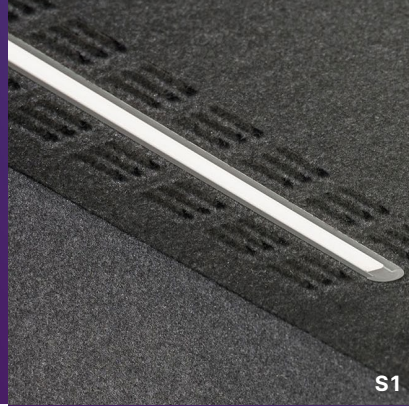

◀ **Lights**  
Energy-efficient LED lights controlled by the presence detectors.

S1



S1

◀ **Exterior**  
Laminated wood exterior sides and trims.

**Aluminum Profiles & Gasket** ▶  
For doors, glass wall and inside connections.



◀ **Glass**  
6+6 mm laminated soundcontrol clear glass.

**Hinges**  
Door profile-to-glass hinge that seals the door perfectly.

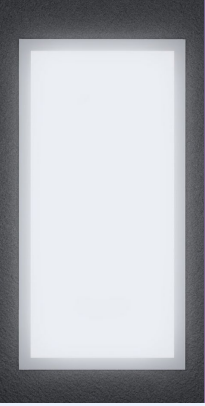

▲ **Laptop Table**  
Standard 1050mm / 41" metal built-in table with whiteboard.



S1

▲ **Textile Sides (optional)**  
Quest fabric selection for Silen Dynamics exterior walls only.

▶ **Air Ventilation**  
Automated air circulation.



◀ **Door**  
Right or left-handed orientation.



S1

◀ **Integrated Power Outlet**  
110 V + USB + USB-C.

▶ **Built-in floor power outlet**  
2 × 110 V + 2 × USB.

