

WOLLENIUM

Bridges
Connect



distributed exclusively in Canada by
WOLLENIUM®

manufactured by
silén



wallenium.ca

Wallenium Partition Walls Inc.
7-1238 Homer Street
Vancouver, BC
V6B 2Y5
CANADA

Certified Quality



Our acoustic pods, manufactured by **Silen**, hold certification under the premier **North American Standard UL 962** for **Canada** and **the USA**. This **certificate** confirms that these products have undergone comprehensive testing as **complete units**.

ASTM E84
CLASS A

As part of the certification, Silen's products have successfully passed the **ASTM E84** standard **fire tests** and have been granted a **Class A rating** in **fire resistance**.



Our commitment to adhering to the **strictest regulations** is reflected in **materials** used in our pods, which are entirely **compliant**. This dedication has resulted in **all Silen booths** achieving **Carbon Neutrality certification**. This certification means that we have **followed The Carbon Neutral Protocol**, to make a clear, credible, and transparent claim of our carbon neutral action.



Product Line

Silen Bridges

Connect your spaces

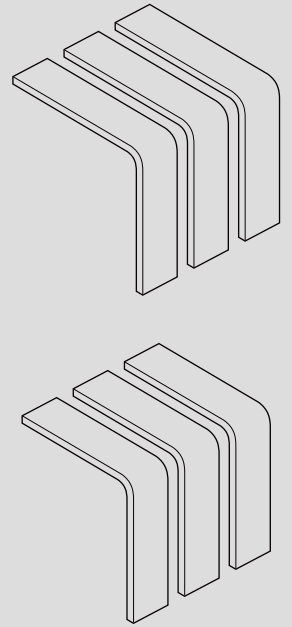

CONNECT

Huddle up

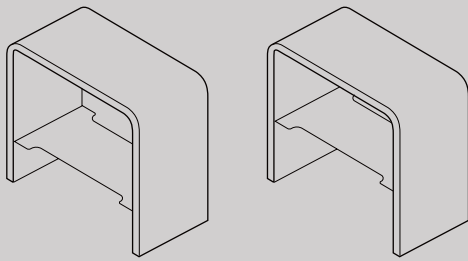

BOND



Summit in style

Bridge the gaps between your spaces

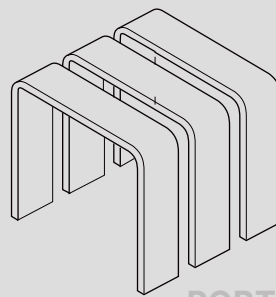
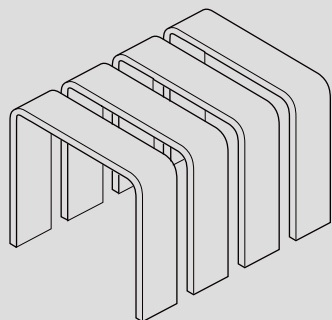
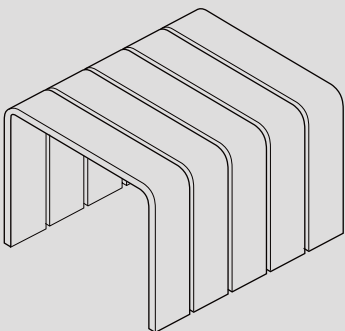

PORTAL

Features

Inner construction panels

Wood, metal, acoustic wool

Screen bracket

VESA mounting with power outlet for screen
*optional (not included)

Cover panels & side trims

Acoustic panels covered with fire resistant & recycled fabrics from **Camira** partnership with the Seaqual initiative. Available in 27 colour shades.



Lighting

The energy-efficient LED lights.
*optional (not included)

Booth/wall fittings

Painted MDF / Metal connectors
(Connect 240/280 only)



Electrical Connection

5m long power cord fed through the ceiling or floor to 120V power outlet.

Plinth

Painted steel

Adjustable legs

For levelling and stability

Carpet

*optional (not included)

Furniture

Lounge chairs, benches, tables and many other options.
*optional (not included)



Mobile, modular, & instantly customizable.



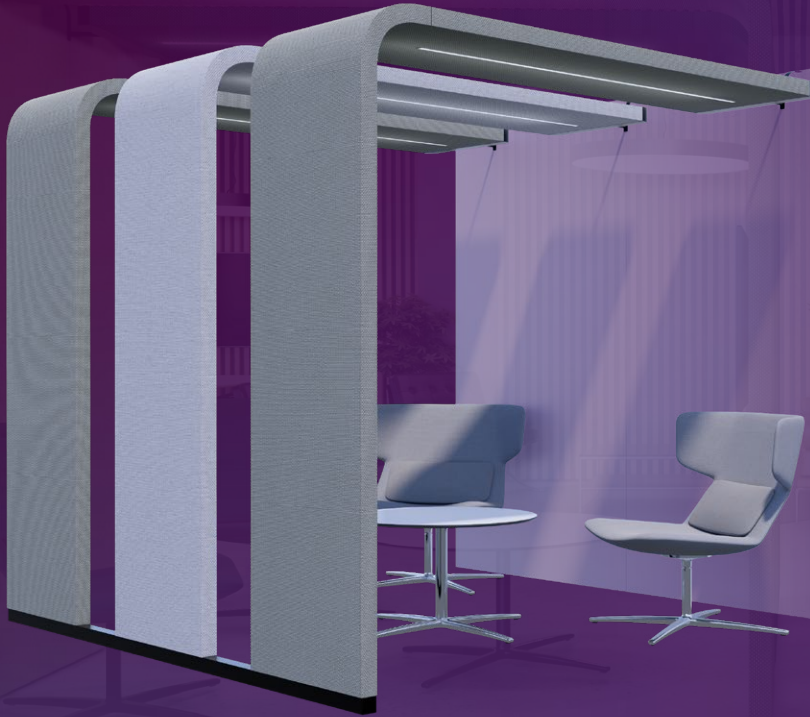

Bridge Connect 240

CONNECT YOUR SPACES IN STUNNING DESIGN

Transform your workspace with **Bridges Connect** - the powerful **new innovation** designed to upgrade your **Space** office pod. **Easy connectivity** and **mobility** also allows attachment to walls and other items.

* Furniture / pod not included

Flexible Setups



Blue Tiber pod + Rock Pool arches

SMax Conference Room + Connect Lounge

Conference acoustic booth for team meetings for up to 7 people combined with Bridge Connect with lounge for 4 people.



Sea Foam & Urchin arches + Mint pod

Connect Co-working Station + S4 Lounge

Bridge 4-people capacity shared workstation for collaborative meetings combined with Space 4 acoustic video conferencing lounge.



Modular



Mix & match with pods



Create zones



Easy to relocate



Easy to install



Reusable & recyclable



No floor fastening

Measurements

Bridge Connect 240

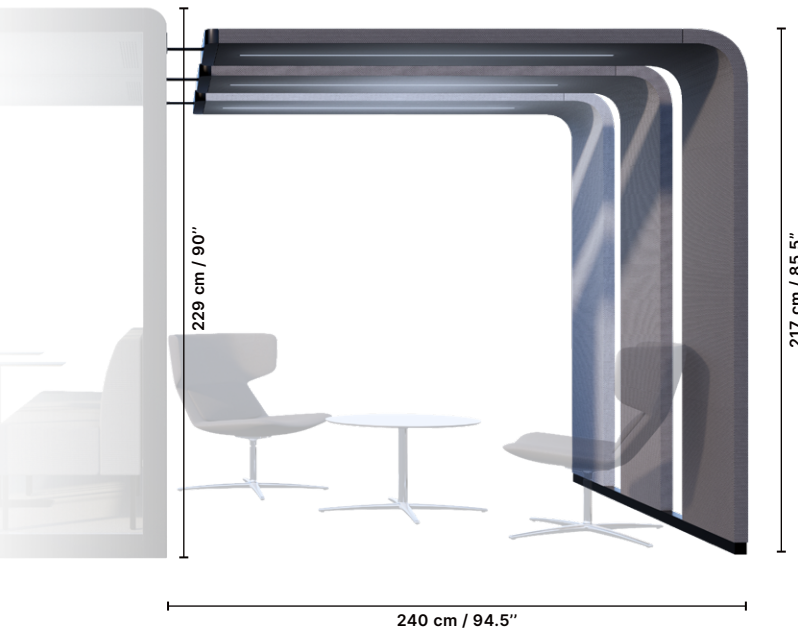

Bridge Connect 240 ▲
front view

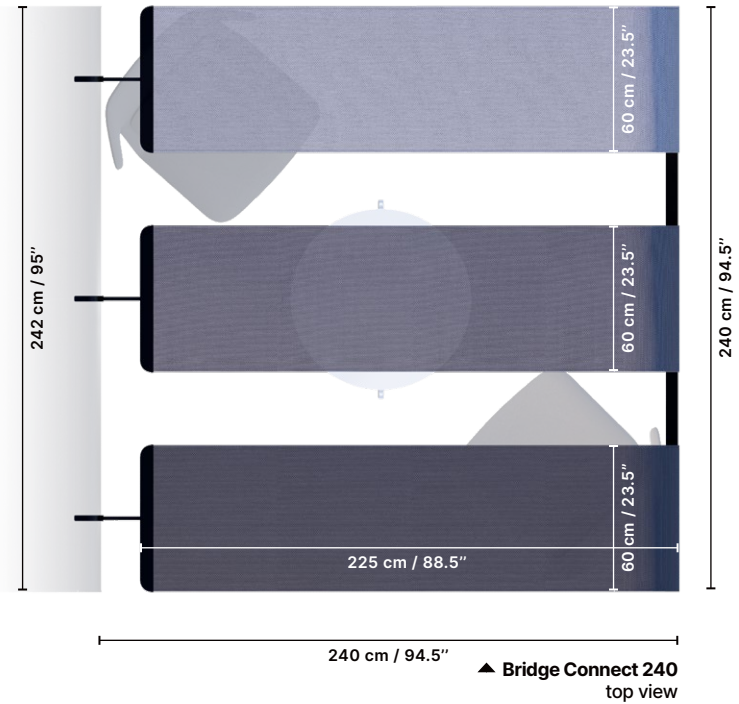

▲ Bridge Connect 240
top view

Bridges Connect 240 Lounge

Furnished with lounge chairs & coffee table.

Specification

Capacity
1-8 people

Size
Outer: W cm/in, H cm/in, D cm/in
240/94.5 217/85.5 240/94.5

Setup
Connects with pods or other solid attachment points;
3 arches with 30 cm / 12" gap

Lighting*
LED light; 4000K (3000K per request)
with motion section in each arch;
energy - efficient

Power socket*
2 × 110V + USB-A / USB-C

Power connection
Through the floor or ceiling;
plug to 15 Amp power outlet

Inner construction panels
Wood, metal, acoustic wool

Booth/wall fittings
Painted MDF
Metal connectors

Cover panels & side trims
Acoustic panels covered with 100%
post-consumer recycled polyester
textile including 75% SEAQUAL®
YARN made from sea plastic

Plinth
Painted steel

Adjustable legs
For leveling and stability

Screen bracket*
VESA 100 × 100 and 200 × 200
mounting with power socket for
screen

Connection options

- Fix to **Space 4** or **Space Max**
- Fix to the **wall**
- Hang from the **ceiling**

Finish selections

Fittings colours



Textiles

Quest fabric selection



* optional

ASTM E84
CLASS A

UL LISTED
US UL 962

CERTIFIED
CARBON
NEUTRAL
Product

Get Inspired
with **Connect 240**



¹ Space Max conference room + **Bridge Connect 240** lounge



² **Bridge Connect 240** co-working zone + Space 4 meeting room + **Bridge Connect 240** lounge



Bridge Connect 280

CONNECT YOUR SPACES IN STUNNING DESIGN

Transform your workspace with **Bridges Connect** - the powerful **new innovation** designed to upgrade your **Space** office pod. **Easy connectivity** and **mobility** also allows attachment to walls and other items.

* Furniture / pod not included

Flexible Setups



— Frozen Blue pod + — Whelk, Limpet & Ripple arches

S4 Meeting Room + Connect Meeting Space

Conference acoustic booth for team meetings for up to 7 people combined with Bridge Connect with lounge for 4 people.



— Sea Grass Bridge arches + — Abalone & Cotton Space Pod

Connect Video Call Lounge + SMax Meeting Lounge

Bridge 4-people capacity shared workstation for collaborative meetings combined with Space 4 acoustic video conferencing lounge.



Modular



Mix & match with pods



Create zones



Easy to relocate



Easy to install



Reusable & recyclable



No floor fastening

Measurements

Bridge Connect 280

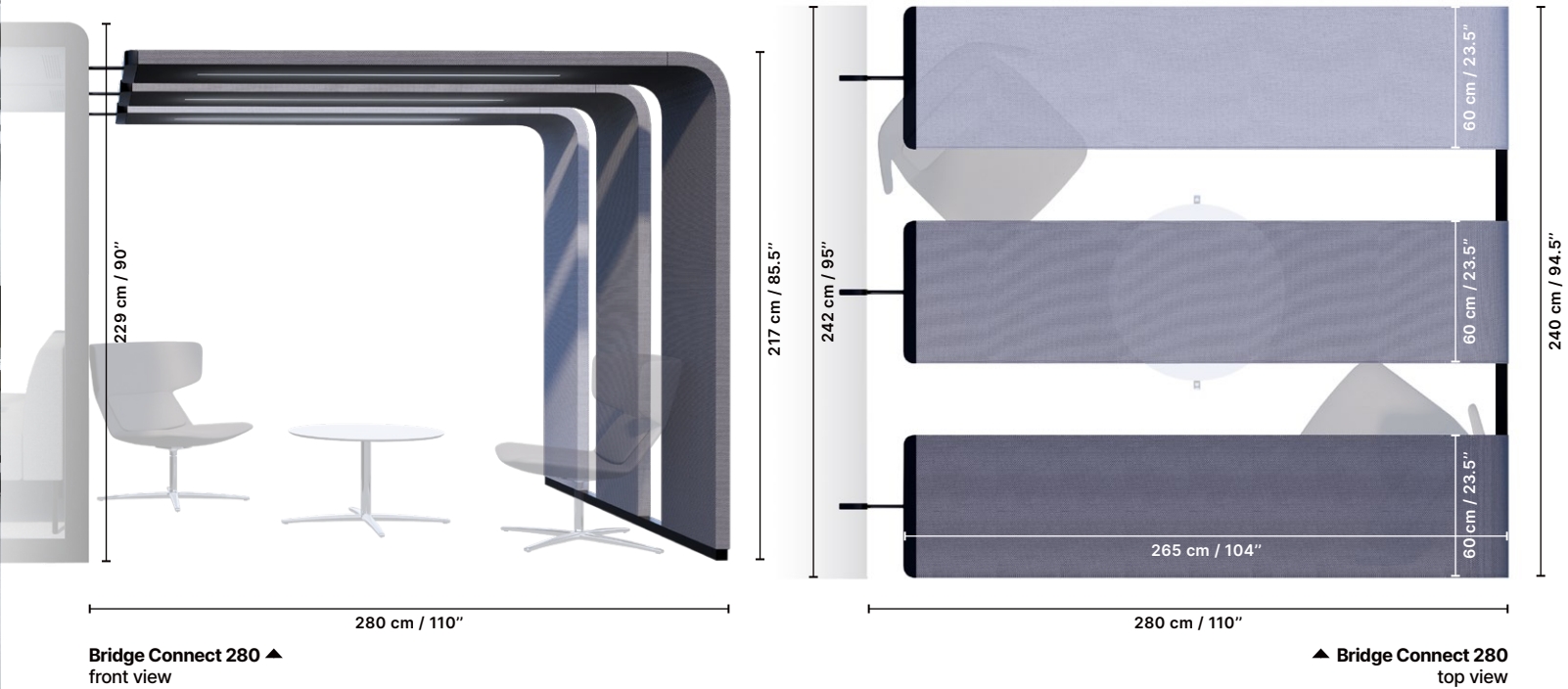

▲ Bridge Connect 280
front view

▲ Bridge Connect 280
top view

Bridges Connect 280 Lounge

Furnished with lounge chairs & coffee table.

Specification

Capacity
1-8 people

Size
Outer: W cm/in, H cm/in, D cm/in
280/110 217/85.5 240/94.5

Setup
Connects with pods or other solid attachment points;
3 arches with 30 cm / 12" gap

Lighting*
LED light; 4000K (3000K per request)
with motion section in each arch;
energy - efficient

Power socket*
2 × 110V + USB-A / USB-C

Power connection
Through the floor or ceiling;
plug to 15 Amp power outlet

Inner construction panels
Wood, metal, acoustic wool

Booth/wall fittings
Painted MDF
Metal connectors

Cover panels & side trims
Acoustic panels covered with 100%
post-consumer recycled polyester
textile including 75% SEAQUAL®
YARN made from sea plastic

Plinth
Painted steel

Adjustable legs
For leveling and stability.

Screen bracket*
VESA 100 × 100 and 200 × 200
mounting with power socket for
screen

Connection options

- Fix to **Space 4** or **Space Max**
- Fix to the **wall**
- Hang from the **ceiling**

Finish selections

Fittings colours



Textiles

Quest fabric selection



* optional

ASTM E84
CLASS A

UL LISTED
US UL 962

CERTIFIED
CARBON
NEUTRAL
Product

Get Inspired with Connect 280



¹ Bridge Connect 280 video conference space + Space Max private lounge



² Space Max meeting room + Bridge Connect 280 acoustic lounge

Finish Selections

Fittings Colours



Fixed Table Tabletop Colours

Fenix NTM matte laminate with bevelled plywood edge.



Textile Colours (Cover Panels & Side Trims)

QUEST - Eco-friendly fabric from Camira.

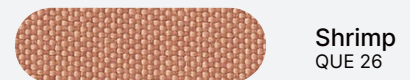
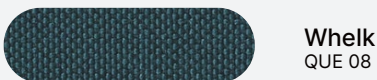
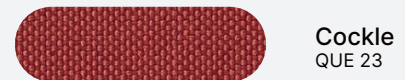
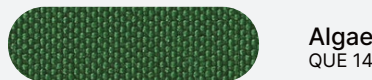
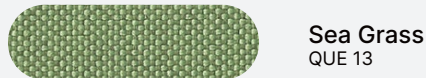
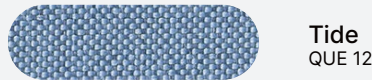
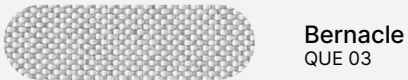
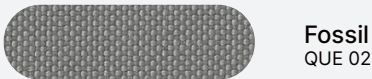

Best Features & High-End Materials

silen



Bridges Portal / Connect

◀ **Arches**
Acoustically-enhanced arcs.



◀ **Connections**
Wall / ceiling / Space booth metal connectors and fittings.

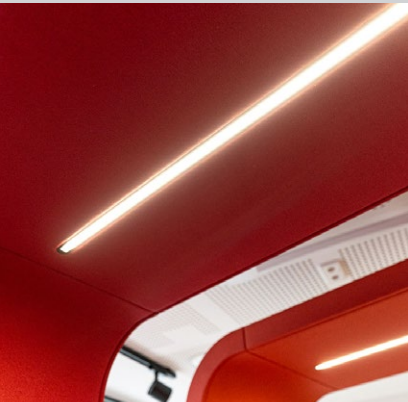

Lights ▶
Energy efficient LED lights controlled by the presence detectors.



Bridges Bond



Bridges Connect

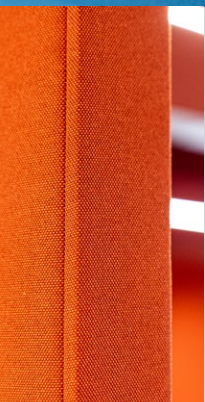

◀ **Exterior**
Laminated wood exterior sides and trims.



Aluminum Profiles & Gasket ▶
For doors, glass wall and inside connections.



▲ **Panels & Side Trims**
Acoustic panels covered with 100% recycled textile from Quest fabric selection.

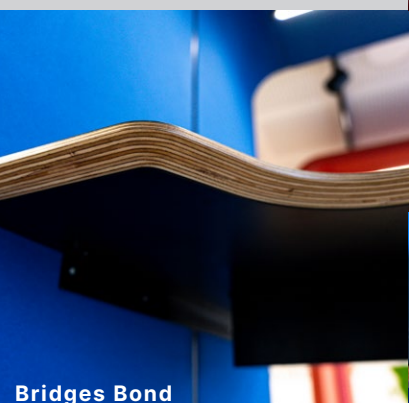

Cable hatch & tray ▶
Hatch with a cable tray under the table, including 110V socket.



Bridges Bond

▲ **Optional add-ons**

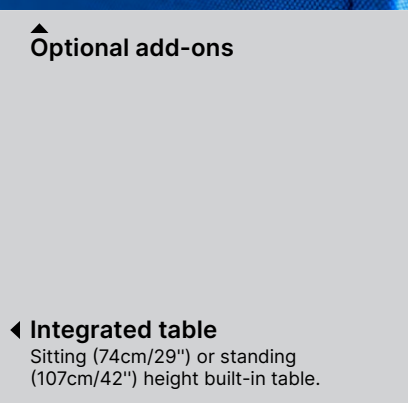

◀ **Integrated table**
Sitting (74cm/29") or standing (107cm/42") height built-in table.

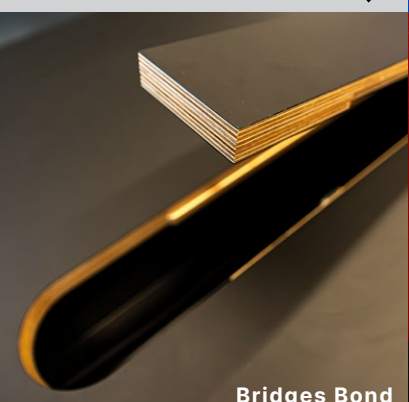

◀ **Plinth**
Painted steel base with adjustable legs for leveling and stability.



Integrated Power Outlet ▶
2 × 110 V + USB + USB-C.



Bridges Bond

