

WOLLENIUM

Bridges
Portal



distributed exclusively in Canada by
WOLLENIUM®

manufactured by
silén



wallenium.ca

Wallenium Partition Walls Inc.
7-1238 Homer Street
Vancouver, BC
V6B 2Y5
CANADA

Certified Quality



Our acoustic pods, manufactured by **Silen**, hold certification under the premier **North American Standard UL 962** for **Canada** and **the USA**. This **certificate** confirms that these products have undergone comprehensive testing as **complete units**.

ASTM E84
CLASS A

As part of the certification, Silen's products have successfully passed the **ASTM E84** standard **fire tests** and have been granted a **Class A rating** in **fire resistance**.



Our commitment to adhering to the **strictest regulations** is reflected in **materials** used in our pods, which are entirely **compliant**. This dedication has resulted in **all Silen booths** achieving **Carbon Neutrality certification**. This certification means that we have **followed The Carbon Neutral Protocol**, to make a clear, credible, and transparent claim of our carbon neutral action.



Product Line

Silen Bridges

Connect your spaces

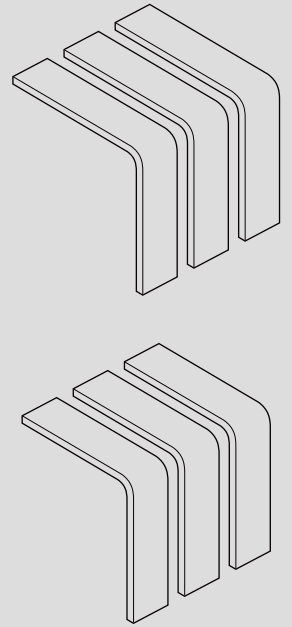

CONNECT

Huddle up

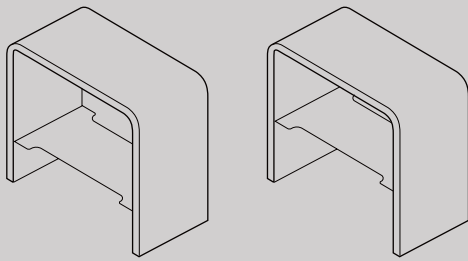

BOND



Summit in style

Bridge the gaps between your spaces

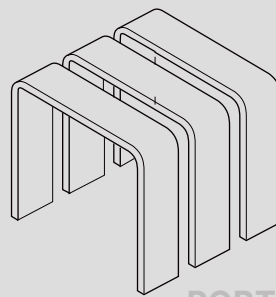
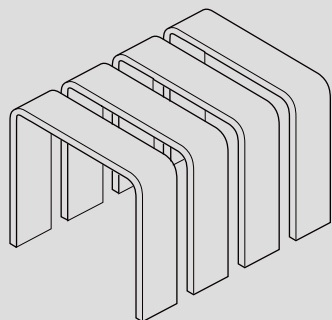
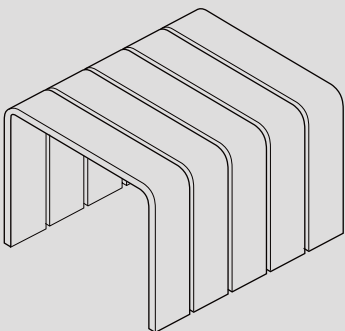

PORTAL

Features

Inner construction panels

Wood, metal, acoustic wool

Screen bracket

VESA mounting with power outlet for screen
*optional (not included)

Cover panels & side trims

Acoustic panels covered with fire resistant & recycled fabrics from **Camira** partnership with the Seaqual initiative. Available in 27 colour shades.



Lighting

The energy-efficient LED lights.
*optional (not included)

Booth/wall fittings

Painted MDF / Metal connectors
(Connect 240/280 only)



Electrical Connection

5m long power cord fed through the ceiling or floor to 120V power outlet.

Plinth

Painted steel

Adjustable legs

For levelling and stability

Carpet

*optional (not included)

Furniture

Lounge chairs, benches, tables and many other options.
*optional (not included)



Mobile, modular, & instantly customizable.



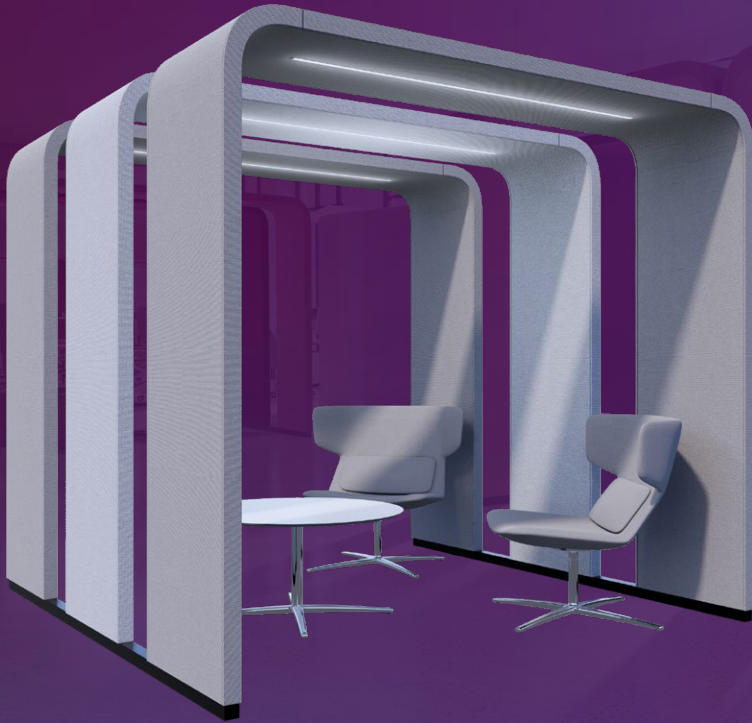

Portal 3

SUMMIT IN STYLE, AND BOOST YOUR PRODUCTIVITY

Create your ideal **summit station** with **Bridges Portal**. **Mobility, modularity** and easy **connectivity** between arcs offer you great **flexibility** in choosing the right space your team needs.

* Furniture not included

Flexible Setups



 Cockle, Crab & Clay arches

Portal Workstation

Conference acoustic booth for team meetings for up to 7 people combined with Bridge Connect with lounge for 4 people.



 Sandstone arches

Portal Meeting Lounge

Bridge 4-people capacity shared workstation for collaborative meetings combined with Space 4 acoustic video conferencing lounge.



Modular



Mix & match with pods



Create zones



Easy to relocate



Easy to install



Reusable & recyclable



No floor fastening

Measurements

Portal 3

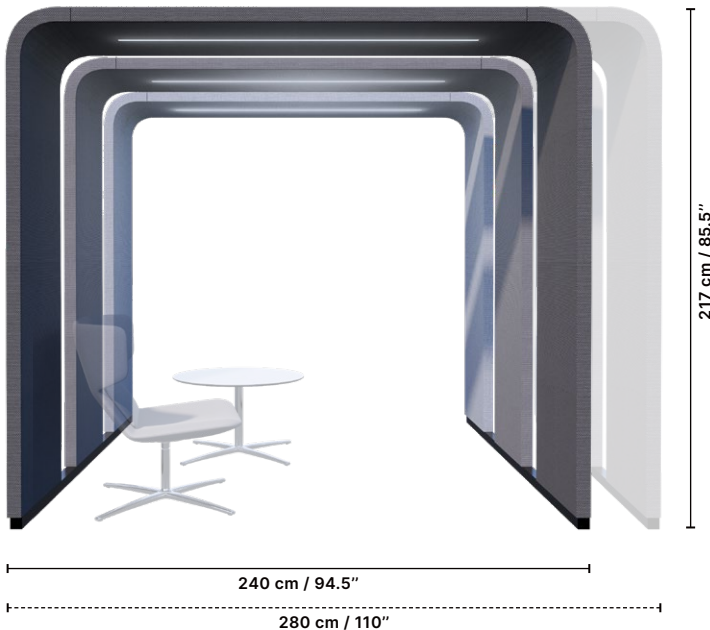

Bridge Portal 3 ▲
front view

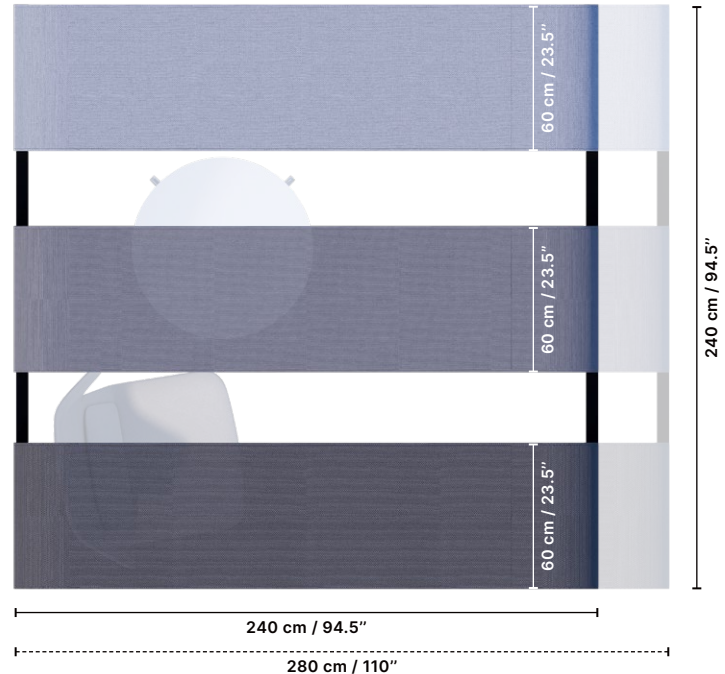

▲ Bridge Portal 3
top view

Bridges Portal 3 Lounge

Furnished with lounge chair & coffee table.

Specification

Capacity

1-∞ people

Size

Outer: W cm/in, H cm/in, D cm/in

240/94.5 217/85.5 240/94.5

280/110 217/85.5 240/94.5

Setup

Freestanding; no fastening needed
3 arches with 30 cm / 12" gap

Lighting*

LED light; 4000K (3000K per request)
with motion sensor in each arch;
energy - efficient

Power socket*

2 × 110V + USB-A / USB-C

Power connection

Through the floor or ceiling;
plug to 15 Amp power outlet

Inner construction panels

Wood, metal, acoustic wool

Cover panels & side trims

Acoustic panels covered with 100%
post-consumer recycled polyester
textile including 75% SEAQUAL®
YARN made from sea plastic.

Plinth

Painted steel

Adjustable legs

For leveling and stability

Screen bracket*

VESA 100 × 100 and 200 × 200
mounting with power outlet for
screen

Options

- Overall width 240 cm
- Overall width 280 cm

Finish selections

Fittings colours



Textiles

Quest fabric selection



* optional

ASTM E84
CLASS A

C  US UL 962
LISTED

CERTIFIED
CARBON
NEUTRAL
product

Get Inspired with Portal 3



¹ Bridge Portal 3 co-working spaces + Space 1 video-call booth



² Bridge Portal 3 meeting lounge

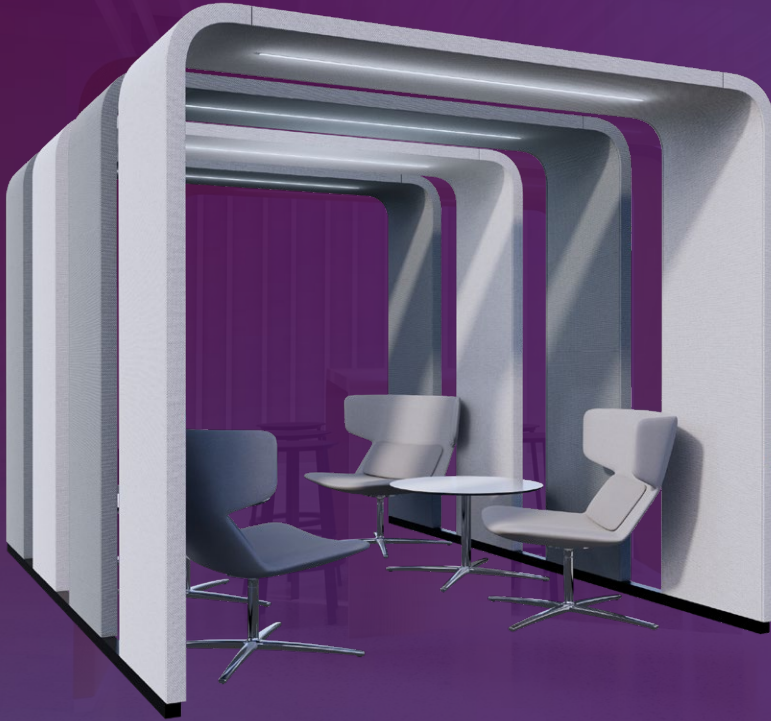
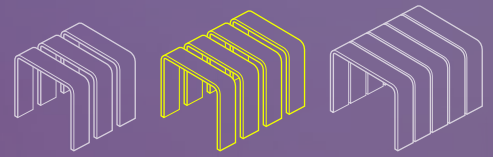

Portal 4

SUMMIT IN STYLE, AND BOOST YOUR PRODUCTIVITY

Create your ideal **summit station** with **Bridges Portal**. **Mobility, modularity** and easy **connectivity** between arches offer you great **flexibility** in choosing the right space your team needs.

* Furniture not included

Flexible Setups



 Abalone arches

Portal Conference Room

Conference acoustic booth for team meetings for up to 7 people combined with Bridge Connect with lounge for 4 people.



 Urchin & Salt arches

Portal Co-working Station

Bridge 4-people capacity shared workstation for collaborative meetings combined with Space 4 acoustic video conferencing lounge.



Modular



Mix & match with pods



Create zones



Easy to relocate



Easy to install



Reusable & recyclable



No floor fastening

Measurements

Portal 4



Bridge Portal 4 ▲
front view

Bridges Portal 4 Meeting Space

Furnished with 360° revolving stools & bar-height table.

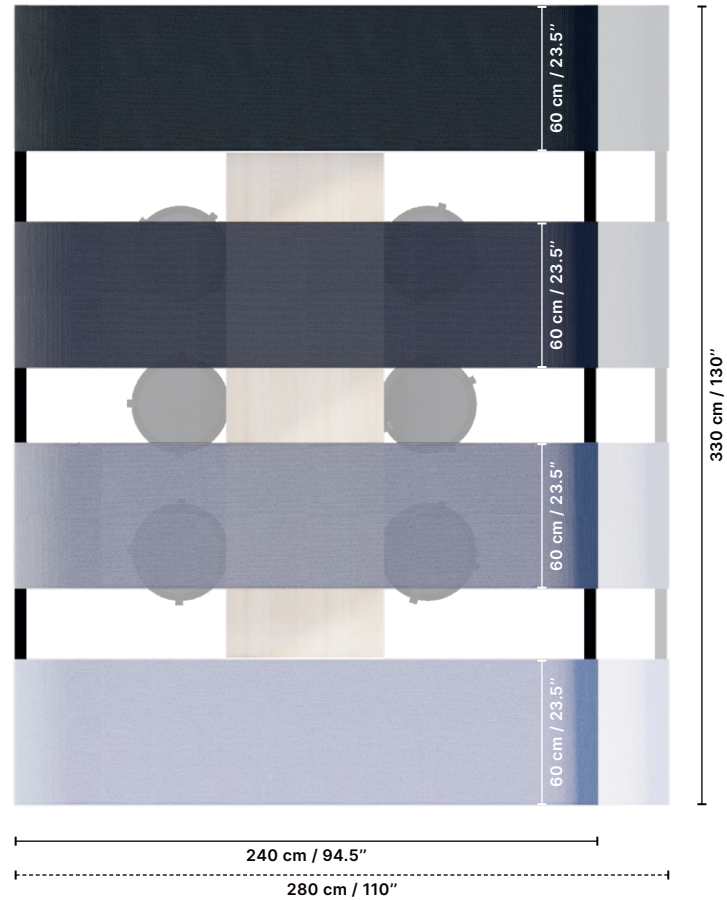

▲ Bridge Portal 4
top view

Specification

Capacity

1-∞ people

Size

Outer: W cm/in, H cm/in, D cm/in
240/94.5 217/85.5 330/130
280/110 217/85.5 330/130

Setup

Freestanding; no fastening needed
 4 arches with 30 cm / 12" gap

Lighting*

LED light; 4000K (3000K per request)
 with motion sensor in each arch;
 energy - efficient

Power socket*

2 × 110V + USB-A / USB-C

Power connection

Through the floor or ceiling;
 plug to 15 Amp power outlet

Inner construction panels

Wood, metal, acoustic wool

Cover panels & side trims

Acoustic panels covered with 100%
 post-consumer recycled polyester
 textile including 75% SEAQUAL®
 YARN made from sea plastic.

Plinth

Painted steel

Adjustable legs

For leveling and stability

Screen bracket*

VESA 100 × 100 and 200 × 200
 mounting with power outlet for
 screen

Options

- Overall width 240 cm
- Overall width 280 cm

Finish selections

Fittings colours



Textiles

Quest fabric selection



* optional

ASTM E84
CLASS A

C  US UL 962
LISTED

CERTIFIED
CARBON
NEUTRAL
product

**Get Inspired
with Portal 4**



¹ Bridge Portal 4 meeting lounge



² Space Max 2X presentation space + Bridge Portal 4 co-working zone

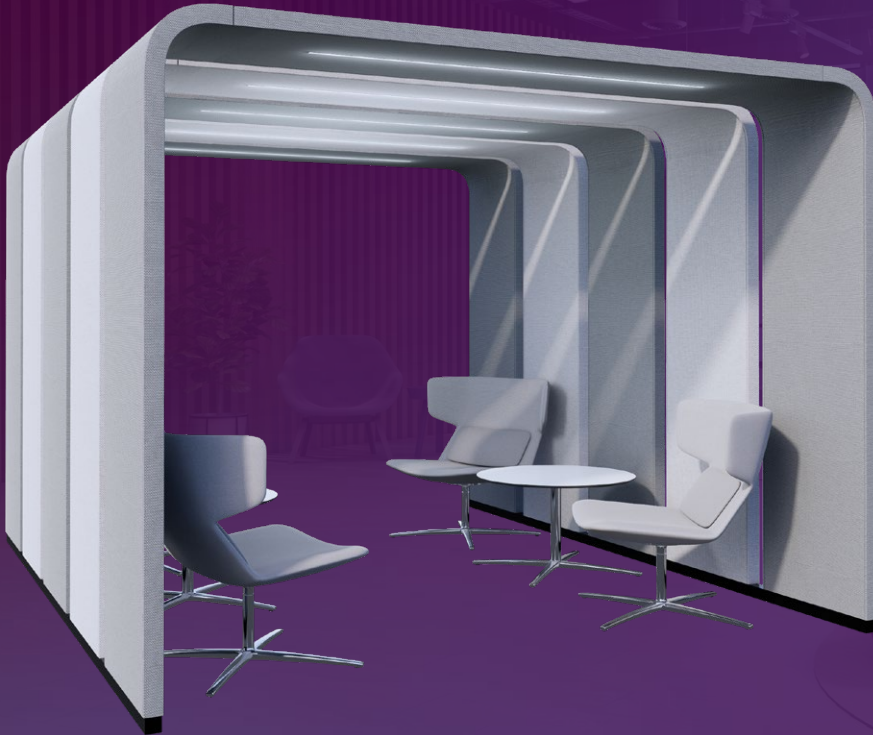

Portal 5

SUMMIT IN STYLE, AND BOOST YOUR PRODUCTIVITY

Discover the power of **collaboration** with **Bridges Portal** - the ultimate **summit station** for **larger gatherings** and **presentations**. With exceptional **acoustics** and endless **customization options**, you can design a perfect space for your team to **ideate and innovate**. Its striking design is sure to be a showstopper in your workspace.

* Furniture not included

Flexible Setups



 Sandstone, Beach Comber & Salt arches

Portal Meeting Lounge

Conference acoustic booth for team meetings for up to 7 people combined with Bridge Connect with lounge for 4 people.

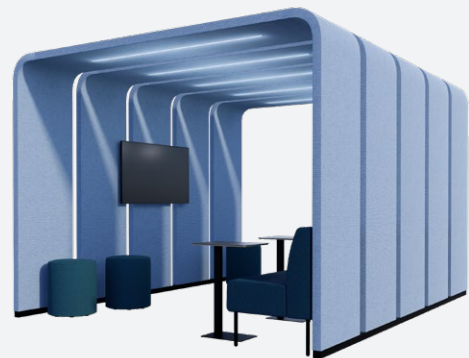

 Tide arches

Portal Video Conferencing Space

Bridge 4-people capacity shared workstation for collaborative meetings combined with Space 4 acoustic video conferencing lounge.



Modular



Mix & match with pods



Create zones



Easy to relocate



Easy to install



Reusable & recyclable



No floor fastening

Measurements

Portal 5

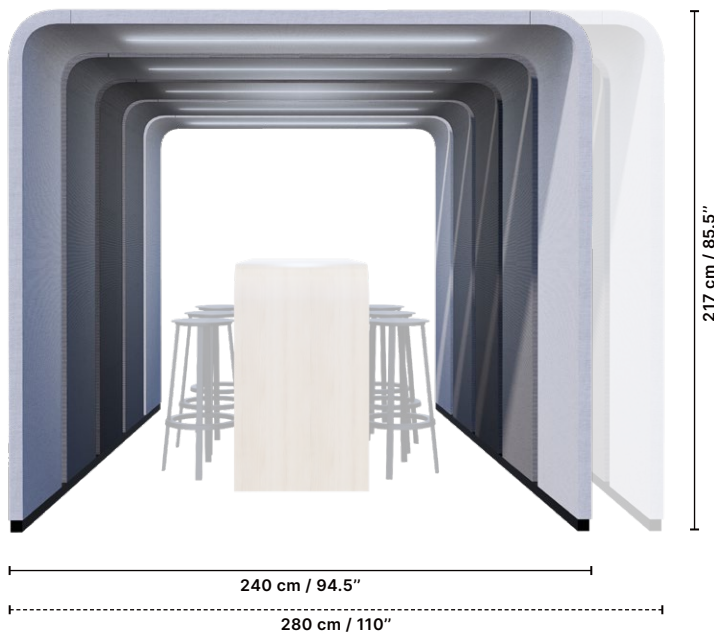

Bridge Portal 5 ▲
front view

Bridges Portal 5 Meeting Space

Furnished with 360° revolving stools & standing height table.

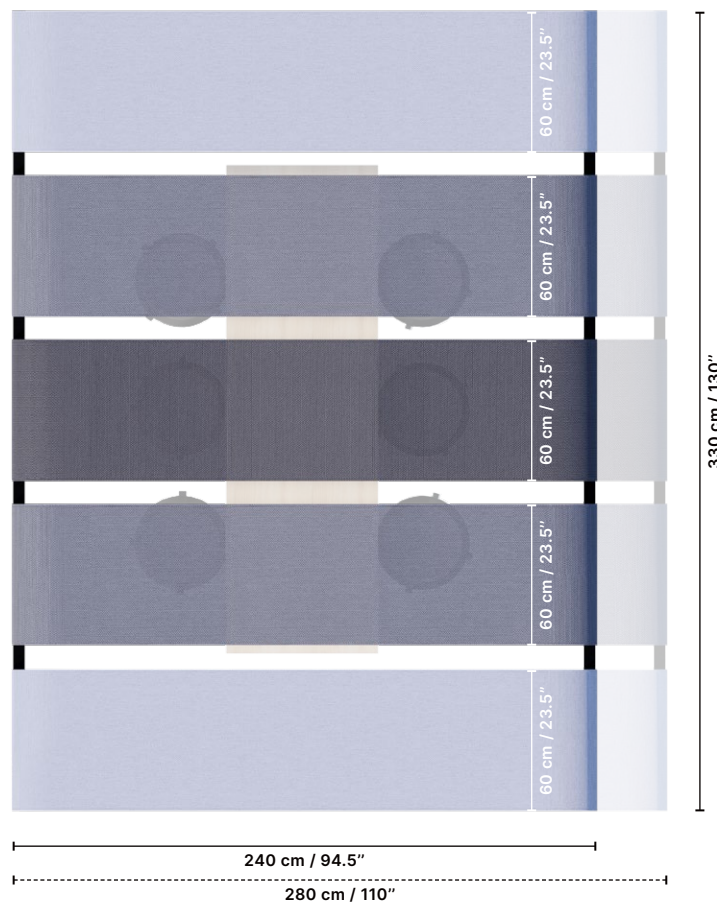

▲ Bridge Portal 5
top view

Specification

Capacity

1-∞ people

Size

Outer: W cm/in, H cm/in, D cm/in

240/94.5 217/85.5 330/130

280/110 217/85.5 330/130

Setup

Freestanding; no fastening needed
5 arches with 7.5 cm / 3" gap

Lighting*

LED light; 4000K (3000K per request)
with motion section in each arch;
energy - efficient

Power socket*

2 × 110V + USB-A / USB-C

Power connection

Through the floor or ceiling;
plug to 15 Amp power outlet

Inner construction panels

Wood, metal, acoustic wool

Cover panels & side trims

Acoustic panels covered with 100%
post-consumer recycled polyester
textile including 75% SEAQUAL®
YARN made from sea plastic.

Plinth

Painted steel

Adjustable legs

For leveling and stability

Screen bracket*

VESA 100 × 100 and 200 × 200
mounting with power outlet for
screen

Options

- Overall width 240 cm
- Overall width 280 cm

Finish selections

Fittings colours



Textiles

Quest fabric selection



* optional

ASTM E84
CLASS A

C  US UL 962
LISTED

CERTIFIED
CARBON
NEUTRAL
product

Get Inspired with Portal 5



¹ Bridge Portal 5 co-working space



² Space 2 Hybrid meeting room + Bridge Portal 5 presentation space

Finish Selections

Fittings Colours



Fixed Table Tabletop Colours

Fenix NTM matte laminate with bevelled plywood edge.



Textile Colours (Cover Panels & Side Trims)

QUEST - Eco-friendly fabric from Camira.

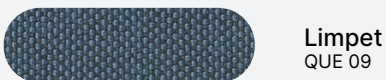
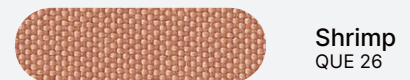
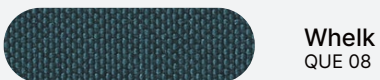
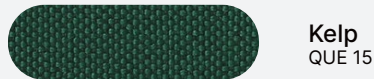
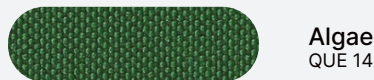
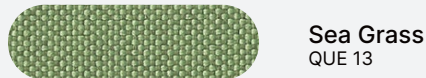
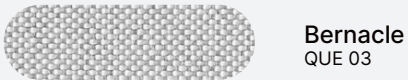
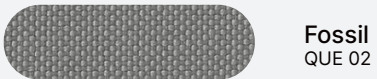

Best Features & High-End Materials

silen



Bridges Portal / Connect

◀ **Arches**
Acoustically-enhanced arcs.

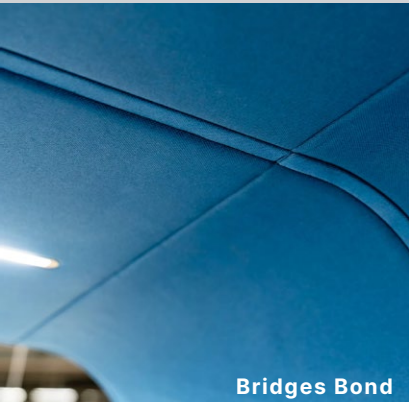

Connections
Wall / ceiling / Space booth metal connectors and fittings.

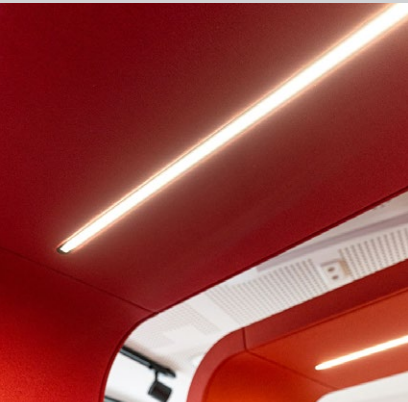

Lights ▶
Energy efficient LED lights controlled by the presence detectors.



Bridges Bond



Bridges Connect

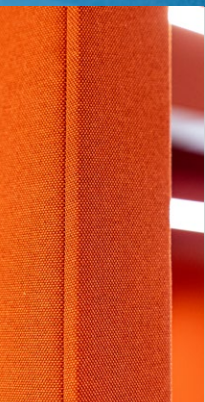

◀ **Exterior**
Laminated wood exterior sides and trims.



Aluminum Profiles & Gasket ▶
For doors, glass wall and inside connections.



▲ **Panels & Side Trims**
Acoustic panels covered with 100% recycled textile from Quest fabric selection.

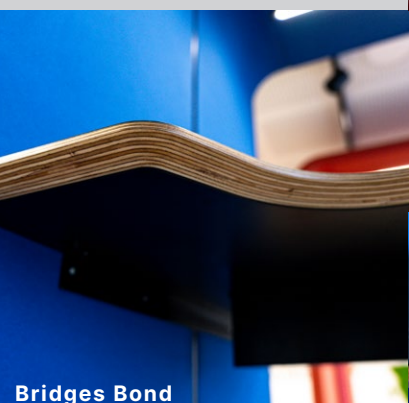

▶ **Cable hatch & tray**
Hatch with a cable tray under the table, including 110V socket.



Bridges Bond

▲ **Optional add-ons**



◀ **Integrated table**
Sitting (74cm/29") or standing (107cm/42") height built-in table.

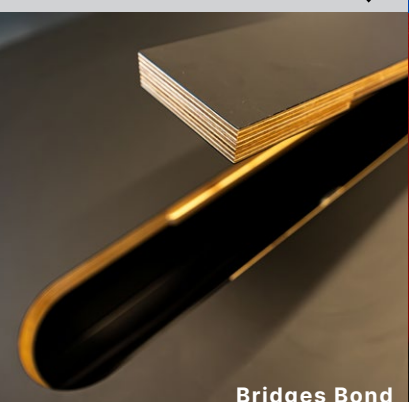

◀ **Plinth**
Painted steel base with adjustable legs for leveling and stability.



Integrated Power Outlet ▶
2 × 110 V + USB + USB-C.



Bridges Bond



