

Acoustic Pods



Space 2 Hybrid

Accessible room for up to 4 people.

THE PLACE TO MEET

S2 Hybrid is a modification of a Space 2 modular pod with all standard S2 features which also works for preferred **touch-free usage**. It features a **barrier-free** design, including the addition of a **low doorstep**, **wide door** and various **optional add-ons**.

By adding **folding chairs**, **foldable table** and **automatic door control**, **S2 Hybrid** becomes an easily **accessible pod** for a wide range of users in **office** or **public spaces**.

* Furniture not included

Flexible Setups



Orange exterior

Video Call Space

Quiet video conferencing pod with a set of folding chairs and a swivel screen integrated into a side panel.



Paprika exterior

Meeting Booth

Soundproof modular room for 2 to 4 people, ensuring uninterrupted and confidential conversations.



Cotton exterior

Quiet Workplace

Private office featuring a height-adjustable desk and pull-out stool. Ideal workspace for one person.



Low doorstep



Modular flexibility



Sound insulation



LED



Acoustic panels



Automated air circulation

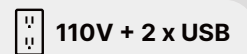

110V + 2 x USB

Measurements

Space 2 Hybrid

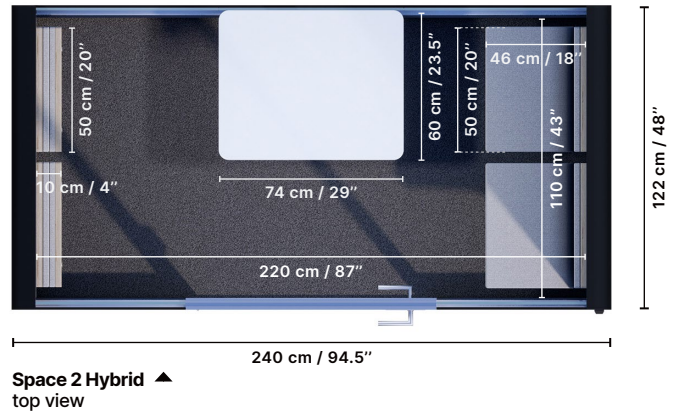
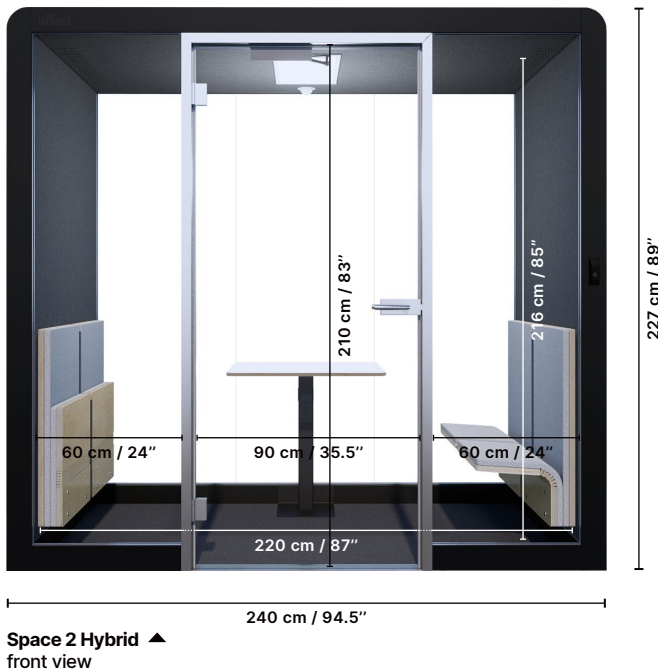

Space 2 Hybrid Meeting Room

Furnished with 2 sets of folding chairs & integrated foldable table.

Interior floor area
2.4 sqm / 26 sqft

Specification

Size

Exterior: W cm/in, H cm/in, D cm/in
240/94 227/89 122/48

Interior: W cm/in, H cm/in, D cm/in
220/87 216/85 110/43

Weight

650 kg / 1433 lb

Door

Wide door; Left or Right

Lighting

LED light; 4000K (3000K per request)
with motion sensor; energy-efficient

Power connection

Through the floor or ceiling;
plug to 15 Amp power outlet

Additional pod features

- Automatic door operator and push-to-open buttons
- Additional Hybrid module (to create S4 Hybrid)

Wall, Ceiling

EchoFree acoustic panels

Floor

Antistatic, stain resistant carpet for public spaces

Glass

6+6 mm acoustic laminated sound control glass

Air ventilation

Low power consumption 6.8W air circulation system (speed - 85l/s; full air exchange time ~62s)

Threshold

Transition 7mm

Adjustable legs

For leveling and stability

- Silen Dynamics Generation: easily exchangeable side skins

Finish selections

Profiles / Door frame



Hinges / Door handle



Interior colours



Exterior colours

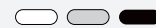

Additional colours



Veneer finishes



- Quest fabric selection for exterior walls only

click to
[Configure S2 Hybrid](#)

ASTM E84
CLASS A

acoustics
40 STC

UL LISTED US UL 962

CERTIFIED
CARBON
NEUTRAL
product

CERTIFIED
ENVIRONMENTALLY
PRESERVABLE PRODUCT
GLOBAL GREEN

Available Add-ons
for Space 2 Hybrid



Accessible Office Booth

- **Automatic door operator**
- **Wave-to-open button**
- **Universal screen bracket**
- **Height-adjustable table** (height: min 700mm, max 1150mm | table top: white; 1100x550mm)
- **Additional wall integrated power socket 2x110V + USB charging ports**
- **Airflow and lighting dimmer**
- **Textile sides** (Quest fabric selection)

- **Black cover trims**
- **Pebble textile sides**
- **Black interior**
- **White profiles**



Video Conference Pod

- **Automatic door operator**
- **Wave-to-open button**
- **Set of folding chairs**
- **Swivel screen bracket** (on right side wall)
- **Gaia movable laptop table** (height: 690mm/27.5")
- **Additional wall integrated power socket 2x110V + USB charging port**
- **Airflow and lighting dimmer**
- **Extra colour laminate**

- **Frozen Blue exterior**
- **Dark Grey interior**
- **Black profiles**



Flexible Meeting Room

- **Automatic door operator**
- **Wave-to-open button**
- **Set of folding chairs**
- **Integrated foldable table** (height: min 730mm | table top: white; 740x580mm)
- **Power socket 2x110V + USB charging ports** (under the table)
- **Additional wall integrated power socket 2x110V + USB charging ports**
- **Extra colour laminate**

- **Mango exterior**
- **Light Grey interior**
- **Grey/Aluminum profiles**



Focused work



Virtual meetings



In-person meetings

Get Inspired
with Space 2 Hybrid



¹ Folding chairs + integrated foldable table



² Height-adjustable table + pull-out stool

scan for
Space 2 Hybrid AR



Finish Selections

Interior Colours

Standard wall and ceiling.

EchoFree acoustic paneling



Light Grey
1893



Dark Grey
1897



Black
1961

Standard floor.

Desso Essence carpet



Light Grey
9507

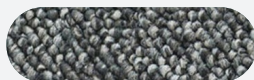

Dark Grey
9502

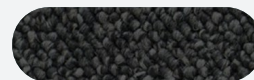

Black
9990

Aluminum Profiles

Doors, glass profiles and inside connections.



White
RAL 9003 profiles
White anodized door fittings



Anodized Grey
Grey anodized profiles



Black
RAL 9005 profiles
Black door fittings

Door Hardware

Handle and hinges.



Anodized Grey
Grey anodized door fittings



Black
RAL 9005 profiles
Black door fittings

Exterior Colours

Standard exterior finishes.

Front and back trims: HPL from Egger and Resopal; Exterior sides: powder-coated metal changeable skins



Snow White
RAL 9013



Silver Grey
RAL 7035



Black
RAL 9011

Modular Sofa Colours

Standard fabric colours.

QUEST - Eco-friendly fabric from Camira.

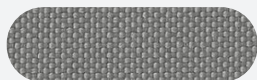

Light Grey
QUE 02



Dark Grey
QUE 04

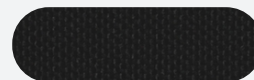

Black
QUE 01

Additional Finishes



Exterior Colours

Additional exterior finishes.

Front and back trims: laminate from Innovus; Exterior sides: powder-coated metal changeable skins

	Cotton RAL 7044		Myosotis RAL 4009
	Basalt RAL 7048		Orange RAL 2008
	Coal RAL 7022		Paprika RAL 2013
	Bambus RAL 120 60 10		Mango RAL 080 80 60
	Mint RAL 6019		Deer RAL 1024
	Jade RAL 6034		Hot Pepper RAL 3020
	Opal RAL 220 40 15		Azurite RAL 5008
	Eden RAL 6005		Blue Tiber RAL 5003
	Citrus Green RAL 100 80 60		Storm Gray RAL 240 50 05
	Marshmallow RAL 040 80 10		Frozen Blue RAL 250 70 10

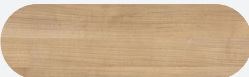
Veneer finishes.

	Oak Veneer R0015 - Planked
	Dark Oak Veneer TH009 - Planked

Additional Finishes

Textile Colours (Modular Sofas & Pod Textile Sides)

Additional fabric colours.

QUEST - Eco-friendly fabric from Camira.



Depth
QUE 01

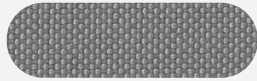

Fossil
QUE 02



Bernacle
QUE 03



Mussel
QUE 04

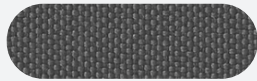

Quartz
QUE 05

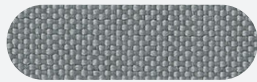

Shell
QUE 06



Ripple
QUE 07

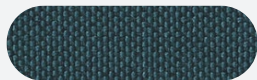

Whelk
QUE 08

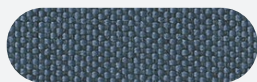

Limpet
QUE 09

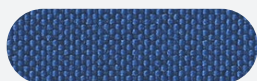

Rock Pool
QUE 10



Wave
QUE 11



Tide
QUE 12

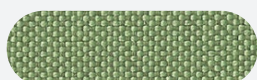

Sea Grass
QUE 13

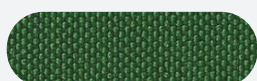

Algae
QUE 14



Kelp
QUE 15



Sea Foam
QUE 16



Urchin
QUE 17



Abalone
QUE 18



Driftwood
QUE 19



Sandstone
QUE 20

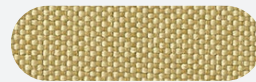

Beach Comber
QUE 21



Salt
QUE 22

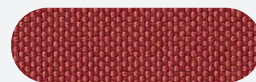

Cockle
QUE 23

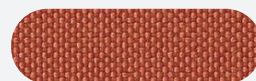

Crab
QUE 24

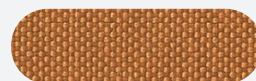

Clay
QUE 25

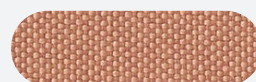

Shrimp
QUE 26

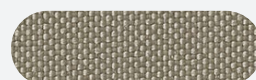

Pebble
QUE 27

Best Features & High-End Materials

silen

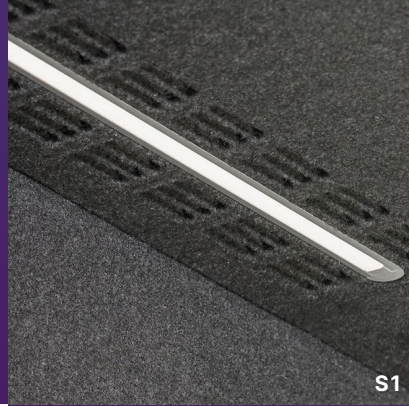

S1

◀ Lights

Energy-efficient LED lights controlled by the presence detectors.



S1

◀ Exterior

Laminated wood exterior sides and trims.

Aluminum Profiles & Gasket ▶

For doors, glass wall and inside connections.



◀ Glass

6+6 mm laminated soundcontrol clear glass.

Hinges

Door profile-to-glass hinge that seals the door perfectly.

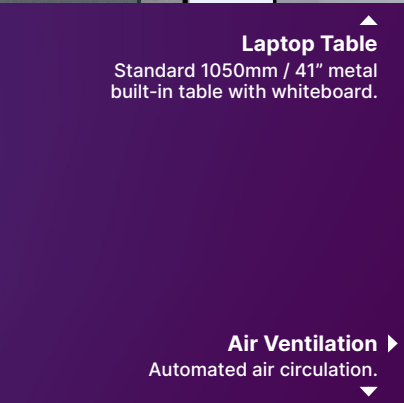
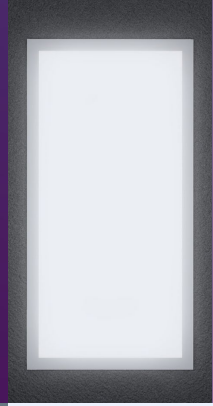

Laptop Table

Standard 1050mm / 41" metal built-in table with whiteboard.



S1

Air Ventilation ▶

Automated air circulation.



Textile Sides (optional)

Quest fabric selection for Silen Dynamics exterior walls only.

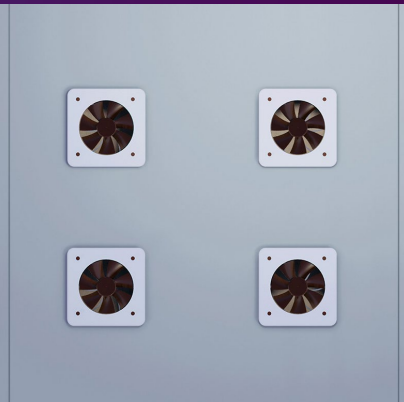

S1

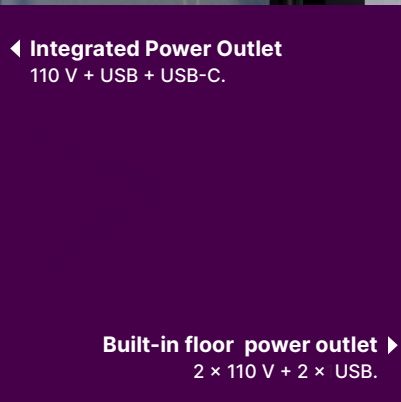

◀ Integrated Power Outlet

110 V + USB + USB-C.

Built-in floor power outlet ▶

2 × 110 V + 2 × USB.