

WOLLENIUM



# Acoustic Pods

## 2024 Product Guide

distributed exclusively in Canada by  
**WOLLENIUM**®

manufactured by  
**silén**



[wallenium.ca](http://wallenium.ca)

**Wallenium Partition Walls Inc.**  
7-1238 Homer Street  
Vancouver, BC  
V6B 2Y5  
CANADA

# Certified Quality



Our acoustic pods, manufactured by **Silen**, hold certification under the premier **North American Standard UL 962** for **Canada and the USA**. This **certificate** confirms that these products have undergone comprehensive testing as **complete units**.

## ASTM E84 CLASS A

As part of the certification, Silen's products have successfully passed the **ASTM E84** standard **fire tests** and have been granted a **Class A rating in fire resistance**.



All of our pods have obtained the **Indoor Advantage Gold certification**, which is **SCS Global Services'** highest level of indoor air quality performance for furniture. This certification guarantees that our furniture products support a **healthy indoor environment** by meeting **strict chemical emission limits** for volatile organic compounds (VOCs).



Our commitment to adhering to the **strictest regulations** is reflected in **materials** used in our pods, which are entirely **compliant**. This dedication has resulted in **all Silen booths** achieving **Carbon Neutrality certification**. This certification means that we have **followed The Carbon Neutral Protocol**, to make a clear, credible, and transparent claim of our carbon neutral action.



Industry-leading **Airborne Sound Insulation tested and proven** in real office environments.

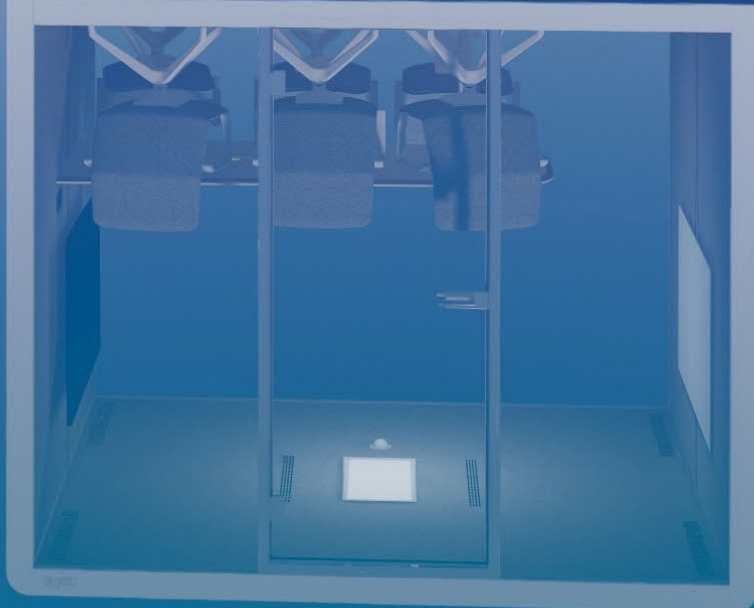

# Product Overview

## Silen Product Line

silen



SPACE 1

p. 16

### PRIVATE ACOUSTIC POD FOR 1 PERSON.

Silen's smallest **movable** and **modular acoustic booths** for the greatest relief to your **open office, commercial, or residential** space.

- phone booth
- private room
- quiet workstation
- video conference pod

acoustics  
41 STC



exterior: W / H / D | 110 × 229 × 110cm | 43 × 90 × 43in  
interior: W / H / D | 90 × 205 × 101cm | 35 × 81 × 40in  
interior floor area: 0.9 sqm / 9.8 sqft



SPACE 1.5

p. 20

### SPACIOUS WORKSTATION FOR 1 PERSON.

Modified S1 acoustic booth with **extra room** for **uninterrupted** work and private **phone calls**.

- lounge phone booth
- flexible workspace
- private office pod
- video conference room

acoustics  
41 STC



exterior: W / H / D | 145 × 229 × 110cm | 57 × 90 × 43in  
interior: W / H / D | 125 × 205 × 101cm | 49 × 81 × 40in  
interior floor area: 1.3 sqm / 13.6 sqft

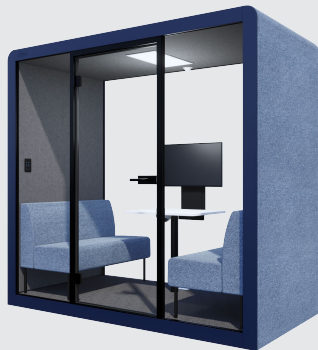

SPACE 2

p. 24

### MODULAR BOOTH FOR UP TO 4 PEOPLE.

The **core module** that allows to create **bigger spaces** and more interior layout configurations.

- meeting room
- video call booth
- private lounge
- quiet workspace

acoustics  
43 STC

Modular flexibility | Wheels included

exterior: W / H / D | 240 × 229 × 122cm | 94 × 90 × 48in  
interior: W / H / D | 220 × 205 × 116cm | 87 × 81 × 46in  
interior floor area: 2.6 sqm / 27.5 sqft



SPACE 2.5

p. 28

### SILENT ROOM FOR UP TO 6 PEOPLE.

Spacious and modular one-person **workstation** available also as a **meeting space** for up to 6 people.

- quiet workstation
- video call space
- meeting booth
- private lounge

acoustics  
43 STC

Modular flexibility | Wheels included

exterior: W / H / D | 240 × 229 × 182cm | 94 × 90 × 72in  
interior: W / H / D | 220 × 205 × 176cm | 87 × 81 × 69in  
interior floor area: 3.9 sqm / 41.7 sqft



## SPACE 4

p. 32

## ACOUSTIC SPACE FOR UP TO 8 PEOPLE.

Two **joined S2 pods** creating one booth that brings the most **flexible** use of a Space acoustic room.

- meeting lounge
- private office
- team workspace
- conference room
- presentation booth

acoustics  
41 STCModular flexibility |  Wheels included

exterior: W / H / D | 240 × 229 × 242cm | 94 × 90 × 95in  
interior: W / H / D | 220 × 205 × 236cm | 87 × 81 × 93in  
interior floor area: 5.2 sqm / 55.9 sqft



## SPACE 4.5

p. 36

## LARGER BOOTH FOR UP TO 10 PEOPLE.

Extended S4 variation with more space for **team meetings**, private **conversations**, **presentations**, and **uninterrupted work**.

- private office
- team workspace
- presentation pod
- meeting lounge
- video conference booth
- quiet boardroom

acoustics  
41 STCModular flexibility |  Wheels included

exterior: W / H / D | 240 × 229 × 302cm | 94 × 90 × 119in  
interior: W / H / D | 220 × 205 × 296cm | 87 × 81 × 117in  
interior floor area: 6.5 sqm / 70.1 sqft



## SPACE 6

p. 40

## SPACIOUS ROOM FOR UP TO 12 PEOPLE.

This large **modular** and **movable** office booth comes with enough room for creative **team meetings** and **all-day work**.

- private lounge
- acoustic boardroom
- conference room
- presentation space
- quiet workspace

acoustics  
41 STCModular flexibility |  Wheels included

exterior: W / H / D | 240 × 229 × 362cm | 94 × 90 × 143in  
interior: W / H / D | 220 × 205 × 356cm | 87 × 81 × 140in  
interior floor area: 7.8 sqm / 84.3 sqft



## SPACE Max

p. 44

## QUIET WORKSPACE FOR UP TO 8 PEOPLE.

Wider **acoustic pod** with **bigger** inside space for more **flexible** use and high capacity **meetings**.

- meeting booth
- presentation lounge
- video call space
- private office

acoustics  
40 STCModular flexibility |  Wheels included

exterior: W / H / D | 280 × 229 × 242cm | 110 × 90 × 95in  
interior: W / H / D | 260 × 205 × 236cm | 102 × 81 × 93in  
interior floor area: 6.1 sqm / 66.1 sqft



## SPACE Max 2X

p. 48

## LARGE ACOUSTIC BOOTH FOR 10 TO 16 PEOPLE.

The most **spacious soundproof** office booth that perfectly works as a **conference** or **presentation** room for bigger **team gatherings**.

- meeting space
- private office
- presentation room
- quiet team pod
- boardroom
- classroom

acoustics  
40 STCModular flexibility |  Wheels included

exterior: W / H / D | 280 × 229 × 482cm | 110 × 90 × 190in  
interior: W / H / D | 260 × 205 × 476cm | 102 × 81 × 188in  
interior floor area: 12.4 sqm / 133.2 sqft

silen



WS Hybrid

p. 52

**ACCESSIBLE POD FOR 1 USER.**

This smallest **Hybrid office pod** is a **barrier-free space** that provides anyone the opportunity to **work in silence** and **privacy**.

- acoustic **phone booth**
- barrier-free **private room**
- **video conference** pod
- quiet **workstation**

acoustics  
**40 STC**Easy  
access

**exterior: W / H / D | 177 × 227 × 122cm | 70 × 89 × 48in**  
**interior: W / H / D | 157 × 216 × 110cm | 62 × 85 × 43in**  
**interior floor area: 1.7 sqm / 18.6 sqft**



SPACE 2 Hybrid

p. 56

**ACCESSIBLE S2 MODEL FOR 2 TO 4 PEOPLE.**

**Low doorstep** version of a regular S2 **acoustic space** with multiple available add-ons and additional features for **easier access**.

- flexible **meeting room**
- **video call** space
- accessible **office booth**

acoustics  
**40 STC**Modular  
flexibilityEasy  
access

**exterior: W / H / D | 240 × 227 × 122cm | 94 × 89 × 48in**  
**interior: W / H / D | 220 × 216 × 110cm | 87 × 85 × 43in**  
**interior floor area: 2.4 sqm / 26 sqft**



SPACE 2.5 Hybrid

p. 60

**SPACIOUS WORKSTATION FOR 1 USER.**

S2.5 Hybrid accessible space perfectly works as a **one-person workstation** or **meeting room** for up to **6 people**.

- quiet **workspace**
- barrier-free **private room**
- **video conference** pod
- accessible **meeting space**

acoustics  
**40 STC**Modular  
flexibilityADA  
compliant

**exterior: W / H / D | 240 × 227 × 182cm | 94 × 89 × 72in**  
**interior: W / H / D | 220 × 216 × 170cm | 87 × 85 × 67in**  
**interior floor area: 3.7 sqm / 40.3 sqft**



SPACE 4 Hybrid

p. 64

**LOW DOORSTEP S4 BOOTH FOR 4 TO 8 PEOPLE.**

2-module accessible **Hybrid pod** with **4 wheelchair user** capacity allows everyone to join in and have a **bigger meeting**.

- accessible **meeting room**
- **video conference** booth
- **private office**

acoustics  
**40 STC**Modular  
flexibilityADA  
compliant

**exterior: W / H / D | 240 × 227 × 242cm | 94 × 89 × 95in**  
**interior: W / H / D | 220 × 216 × 230cm | 87 × 85 × 90in**  
**interior floor area: 5.1 sqm / 54.5 sqft**



MINDSPA

p. 68

**RELAXATION BOOTH FOR 1 PERSON.**

Redesigned S2 **private room** with **premium equipment** and **unique features** for clarity of mind and uninterrupted **meditation**.

acoustics  
**43 STC**Wheels  
included

**exterior: W / H / D | 240 × 229 × 122cm | 94 × 90 × 48in**  
**interior: W / H / D | 220 × 205 × 116cm | 87 × 81 × 46in**  
**interior floor area: 2.6 sqm / 27.5 sqft**



Flexible spaces to **create & focus.**



# Product Overview

## Chatbox Product Line

# CHATBOX



**SINGLE**

p. **84**

### 1-PERSON CAPACITY BOOTH TO FOCUS.

Compact and cost-effective pod for focused **work sessions** and uninterrupted **phone calls**.

- phone booth
- acoustic room
- quiet workstation
- video conferencing pod

acoustics  
**35 STC**

exterior: W / H / D | 100 × 222 × 100cm | 39 × 87 × 39in  
interior: W / H / D | 87 × 204 × 98cm | 34 × 80 × 38in  
interior floor area: 0.9 sqm / 9.2 sqft



**SOLO**

p. **88**

### PRIVATE WORKSTATION FOR 1 PERSON.

Compact and cost-effective pod for focused **work sessions** and uninterrupted **phone calls**.

- lounge phone booth
- private workspace
- video conference room

acoustics  
**35 STC**

exterior: W / H / D | 125 × 222 × 100cm | 49 × 87 × 39in  
interior: W / H / D | 113 × 204 × 93cm | 45 × 80 × 37in  
interior floor area: 1.1 sqm / 11.3 sqft



**DUO**

p. **92**

### ACOUSTIC OFFICE POD FOR 1:1 MEETINGS.

Modular office booth that helps to **focus, connect** and **collaborate**. Perfect for **video calls, meetings** and creative **discussions**.

- meeting space
- private office
- video call lounge

acoustics  
**35 STC**

**Modular flexibility**

exterior: W / H / D | 213 × 222 × 100cm | 84 × 87 × 39in  
interior: W / H / D | 200 × 204 × 93cm | 79 × 80 × 37in  
interior floor area: 1.9 sqm / 20 sqft



**QUATTRO**

p. **96**

### SPACIOUS MEETING SPACE FOR UP TO 6 PEOPLE.

Acoustic pod with enough room to **co-create, brainstorm, work** in privacy, and hold **team meetings**.

- meeting room
- presentation space
- quiet lounge
- video conference pod
- private office

acoustics  
**35 STC**

**Modular flexibility**

exterior: W / H / D | 213 × 222 × 194cm | 84 × 87 × 76in  
interior: W / H / D | 200 × 204 × 186cm | 79 × 80 × 73in  
interior floor area: 3.7 sqm / 40 sqft





Acoustic spaces to work & meet.



# Features

Silen Product Line

"All alone and I like it..."

S1, S1.5

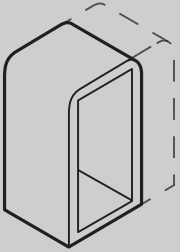

So portable

So modular

S2-S2.5-S4-S4.5-S6

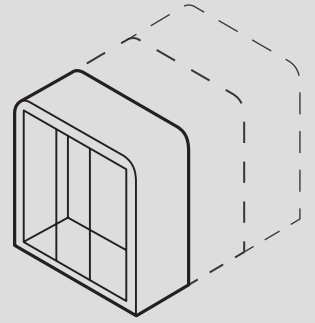

"Connecting with friends and growing..."



Take control of your space

"Privacy for everyone..."

So accessible

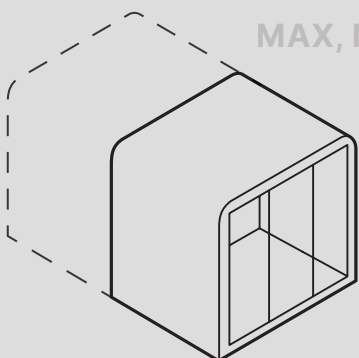

MAX, MAX2X

So spacious

"More space for your creativity & success..."

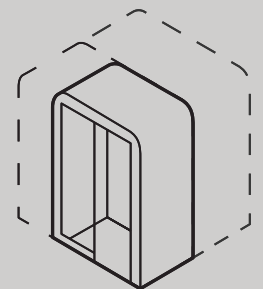

HYBRID

# Features

## Electrical Connection

5m long **power cord** fed through the ceiling or floor to 120V power outlet.

## Air Ventilation

Automated **air circulation**.

## Lighting

The energy-efficient **LED lights**.

## Motion Sensor

The presence detectors.

## Wall, Ceiling

EchoFree **acoustic** panels.

## Exterior

Laminated wood exterior trims in **25 available finishes**.

Metal powder-coated **changeable side skins** in **25 available colours**.

Quest **fabric selection** available for exterior walls only.

## Glass

6+6 mm **soundcontrol** clear **glass** up to 43 STC.

## Air flow & Lighting Dimmer

(optional)

## Door

Right or left-handed.

## Interior

**Fire resistant**, hypoallergenic, antibacterial and scent-free walls and floor materials.

## Furniture

Modular benches, built-in / side tables and many other options.\*optional (not included)

## Modular & Reconfigurable

Joining more Space 2 modules allows you to **create bigger spaces**.

## Power Connections

Electrical **floor or wall sockets** with integrated charging ports.

## Floor

Antistatic, stain resistant carpet.

## Adjustable Legs

For leveling and stability.

## On Wheels

Casters for easy **on-site relocation** without need to uninstall the booth.



## Silen Dynamics Generation

\*optional

### Even more flexible

In addition to the **modular** and **portable** features of Silen acoustic booths, **Silen Dynamics** offers a new level of **flexibility**. Now, you can effortlessly **swap** your **pod faces**, transforming your office space design with ease.

### Swappable exterior skins

Easily **exchangeable side skins** and **cover trims** with **Silen Dynamics** (upon request).

### Make your pod last

With **Silen Dynamics**, your acoustic pod gains even **greater durability**. **Update the look** of your **Space booth** without the need to purchase a new booth. Simply **replace** the pod's **trims** or exterior **sides** to give it a fresh, **updated** appearance.

### Wide spectrum of colours

Available in **23 exterior** colours, **2 oak veneer** shades and **textile** designs.



## Mix, match & create

\*\*only for Silen Dynamics

### Sides and front trims

Get creative and **combine** different colours of **exterior side skins** and front/back **cover trims**.

### Boost your creativity

Utilize your **own designs, textiles**, and special **finishes** to customize the pod's exterior. **Silen Dynamics Generation** offers limitless **customization options**.



# Textile sides

\*\*only for Silen Dynamics

new

## Quest fabric selection

**Fire resistant & recycled** fabrics from **Camira** partnership with the Seaqual Initiative. Available in 27 colour shades.

*Lightly textured fabric woven entirely from recycled plastic.*

*100% post-consumer recycled polyester, including 75% SEAQUAL® YARN*





## Unbeatable

### Modular

Similar to your company's growth and adaptability, our pods **evolve** alongside your needs. Equipped with **hidden wheels**, all movable modules can be easily rearranged. Silen's unique **modular** attachment / detachment **system** streamlines the process. You can also enhance your booth by adding functional **furniture items** and **accessories** from our warehouse.

### Easy to use

Upon installation, your **Space** pod is **plugged into** a regular 15 Amp **power outlet** from the floor or ceiling of your space. Our acoustic booths come with integrated **electrical sockets**, and **USB ports** for **charging devices**. Conveniently **positioned** on the **floor** or **wall panel**, these sockets remain **easily accessible** during any seating arrangement.

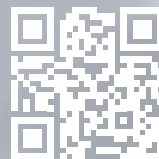

visit us  
online

## Easy to install

Your new **Space** will be installed by professional installation teams who **guarantee** that your first meeting with the Space pods goes smoothly and comfortably. Silen's unique and hassle-free solution is designed to constantly **match the changing needs**. As a **modular system**, benefits you over countless years and through many office spaces.

## Quiet

Tranquility forms the foundation for **optimal concentration** and creativity. **Silen Space** soundproof **pods** become your silent allies, effectively **silencing the noise** of a busy office. Perfectly suitable for private phone calls, confidential discussions and focused work, our pods are crafted using premium **acoustic materials** to **enhance** your daily **workflow**.



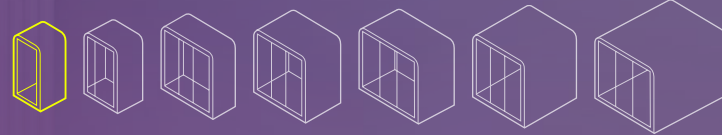

## Space 1

Silent room for 1 person.

### FOR UNINTERRUPTED CALLS

This **flexible** and **movable acoustic room** brings the greatest relief to your space. It creates an **island of silence** in any **open office** concept.

**Space 1** is ready for when you need a break from office noise and distractions. It **brings privacy** for the user and **silence** for colleagues. S1 perfectly works as a small-sized **workstation, phone booth, or video conferencing pod for one person.**

\* Table included only

## Flexible Setups



Silver Grey exterior

### Standard Pod

Acoustic room with integrated table and optional freestanding bar-height chair for private calls or short work.



Frozen Blue exterior

### Video Conference Booth

One-person capacity versatile space with ability to connect your devices and install your own screen.



Opal exterior

### Quiet Workstation

Space 1 booth configuration featuring electrically adjustable table and stool that works as a quiet workstation.





# Measurements

## Space 1

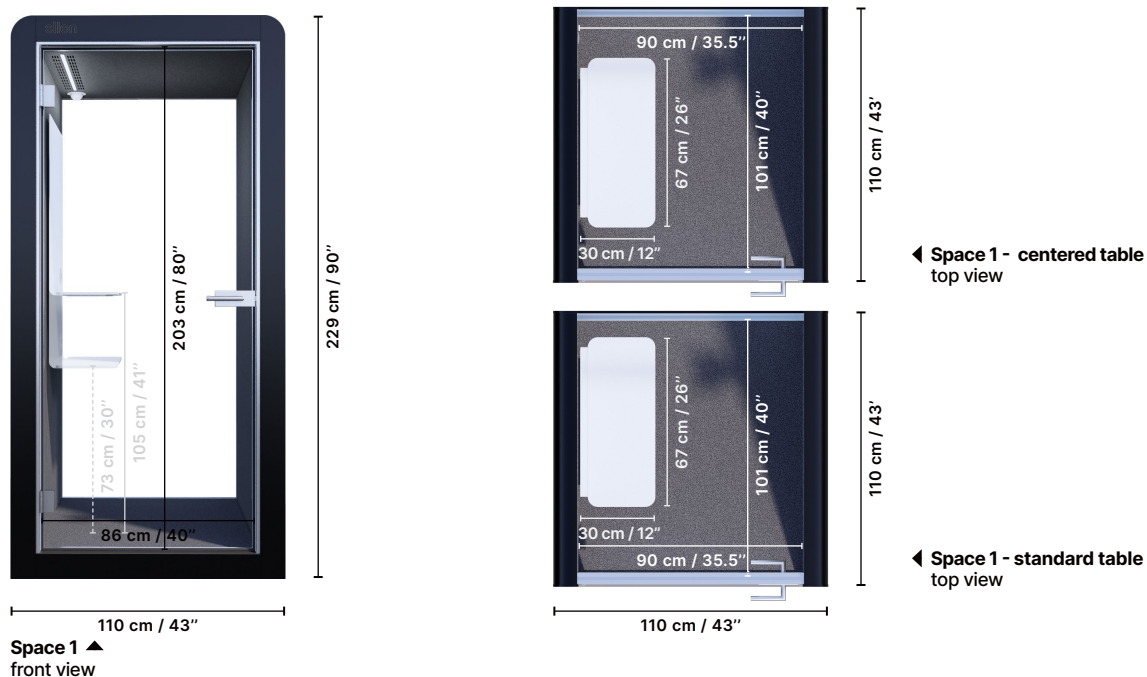

### Space 1 Phone Booth

Furnished with built-in table with power outlets.

Interior floor area  
0.9 sqm / 9.8 sqft

## Specification

### Size

Exterior: W cm/in, H cm/in, D cm/in  
110/43 229/90 110/43

Interior: W cm/in, H cm/in, D cm/in  
90/35 205/81 101/40

### Weight

370 kg / 816 lb

### Door

Left or Right

### Lighting

LED light; 4000K (3000K per request)  
with motion sensor; energy-efficient

### Power connection

Through the floor or ceiling;  
plug to 15 Amp power outlet

### Additional pod features

- Automatic door operator and push-to-open buttons
- Silen Dynamics Generation: easily exchangeable side skins
- Quest fabric selection for exterior walls only

### Wall, Ceiling

EchoFree acoustic panels

### Floor

Antistatic, stain resistant carpet for public spaces

### Glass

6+6 mm acoustic laminated sound control glass

### Air ventilation

Low power consumption 3.4W air circulation system ( speed - 27l/s; full air exchange time ~69s)

### Casters

For easy relocation

### Adjustable legs

For leveling and stability

## Finish selections

### Profiles / Door frame



### Hinges / Door handle



### Interior colours



### Exterior colours



### Additional colours



### Veneer finishes



click to  
**Configure S1**

**ASTM E84**  
CLASS A

acoustics  
**41 STC**

**UL** LISTED  
US UL 962

**CERTIFIED**  
**CARBON**  
**NEUTRAL**  
product

**CERTIFIED**  
ENVIRONMENTALLY  
PREFERABLE PRODUCT  
GLOBAL SOURCE

## Available Add-ons for Space 1



### Video Conference Pod

- Screen bracket + full V/C readiness
- Centered **built-in table** (height: 1050mm/41")
- **Extra face lights** for improved video calls
- **Integrated adjustable swivel stool** (height: min 560mm, max 820mm | seat: ø350mm)
- **Air flow and lighting dimmer**
- **Power socket 110V + USB charging ports**
- **Extra colour laminate**

- Mint exterior
- Light Grey interior
- Black profiles



### Phone Booth

- Standard **built-in table** (height: 1050mm/41") with **magnetic whiteboard**
- Integrated **power socket 110V + USB charging ports**
- **360° revolving stool** (bar-height: 760mm/30")
- **Occupancy indicator light**
- **Extra colour laminate**

- Paprika exterior
- Dark Grey interior
- White profiles



### Private Workstation

- **Height-adjustable table** (height: min 700mm, max 1150mm | table top: 675×273mm)
- **Lightweight stool** (externally sourced)
- **Air flow and lighting dimmer**
- **Power socket 110V + USB charging ports**
- **Textile sides** (Quest fabric selection)

- Deer cover trims
- Mussel textile sides
- Black interior
- Grey/Aluminum profiles



Virtual meetings



Phonecalls



Short work

# Get Inspired with Space 1



<sup>1</sup> V/C ready / standard models, built-in tables + built-in height-adjustable stools



<sup>2</sup> Built-in table + revolving stool

scan for  
**Space 1 AR**





## Space 1.5

Spacious acoustic room for 1 person.

### A PEACEFUL RETREAT FOR SOLO WORK

**S1.5** acoustic pod brings **extra room** for uninterrupted work sessions. With optional **height-adjustable desk add-on**, it creates a flexible **island of silence** for work in louder **open office** concepts.

**Space 1.5** private booth is multifunctional, movable, and just like other Space pods, it **brings privacy** and a **relief from office noise** and **distractions**. S1.5 works as a comfortable **workstation, phone booth, or video conferencing pod** for one person.

\* Standard height-adjustable table included

## Flexible Setups



Eden & Silver Grey exterior

### Phone Booth

Adaptable one-person soundproof space with an integrated table and freestanding 360° revolving chair.



Jade exterior

### Video Conference Pod

Video call room and phone booth with folding chair, ability to install your own screen and connect your devices.



Marshmallow exterior

### Flexible Workspace

Flexible configuration with height-adjustable table and lightweight stool for uninterrupted work sessions.

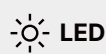

# Measurements

## Space 1.5

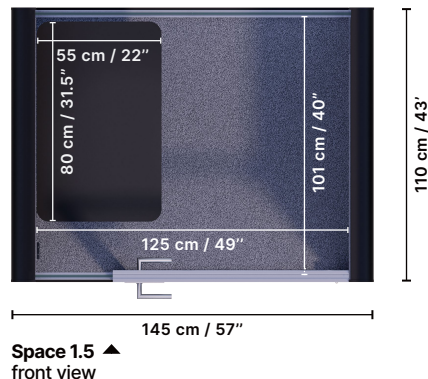
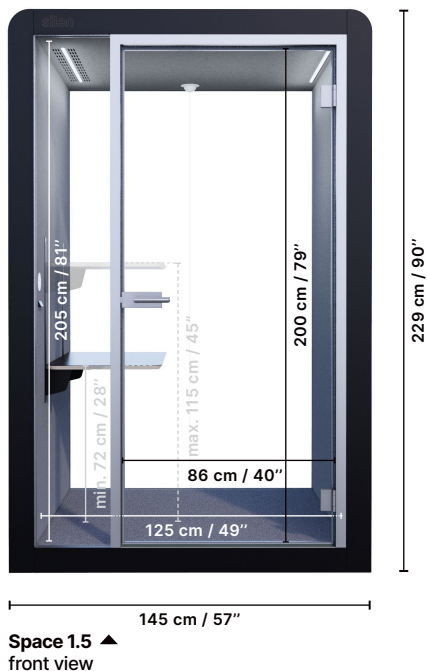

### Space 1.5 Phone Booth

Furnished with built-in height-adjustable table.

Interior floor area  
1.3 sqm / 13.6 sqft

## Specification

### Size

Exterior: W cm/in, H cm/in, D cm/in  
145/57 229/90 110/43

Interior: W cm/in, H cm/in, D cm/in  
125/49 205/81 101/40

### Weight

428 kg / 944 lb

### Door

Left or Right

### Lighting

LED light; 4000K (3000K per request) with motion sensor; energy-efficient

### Power connection

Through the floor or ceiling; plug to 15 Amp power outlet

### Additional pod features

- Automatic door operator and push-to-open buttons
- Silen Dynamics Generation: easily exchangeable side skins
- Quest fabric selection for exterior walls only

### Wall, Ceiling

EchoFree acoustic panels

### Floor

Antistatic, stain resistant carpet for public spaces

### Glass

6+6 mm acoustic laminated sound control glass

### Air ventilation

Low power consumption 6.8W air circulation system ( speed - 80l/s; full air exchange time ~32s)

### Casters

For easy relocation

### Adjustable legs

For leveling and stability

## Finish selections

### Profiles / Door frame



### Hinges / Door handle



### Interior colours



### Exterior colours



### Additional colours



### Veneer finishes



click to  
Configure S1.5

ASTM E84  
CLASS A



## Available Add-ons for Space 1.5



### Private Office Pod

- **Height-adjustable table** (height: min 720mm, max 1150mm | table top: 800×550mm)
- **Task chair** (externally sourced)
- **Air flow and lighting dimmer**
- **Power socket 110V + USB charging ports**
- **Textile sides** (Quest fabric selection)

- Bambus cover trims
- Bernacle textile sides
- Light Grey interior
- Black profiles



### Lounge Phone Booth

- **Fixed-height table** (height: 740mm/29" | table top: white; 800×550mm)
- **Power socket 110V + USB charging ports**
- **Vega low-back task sofa**
- **Occupancy indicator light**
- **Extra colour laminate**

- Opal exterior
- Black interior
- White profiles



### Video Conference Room

- **Screen bracket + full V/C readiness**
- **Centered built-in table** (height: 1050mm/41")
- **Extra face lights** for improved video calls
- **Height-adjustable task chair** (externally sourced)
- **Air flow and lighting dimmer**
- **Power socket 110V + USB charging ports**
- **Extra colour laminate**

- Myosotis exterior
- Dark Grey interior
- Grey/Aluminum profiles



Short work



Phonecalls



Virtual meetings

# Get Inspired with Space 1.5



<sup>1</sup> Built-in fixed table + Vega low-back task sofa



<sup>2</sup> Workstation with height-adjustable desk

scan for  
**Space 1.5 AR**





## Space 2

Silent room for up to 4 people.

### FOR A SMOOTH DIALOGUE

**Space 2** is a stylish **movable modular** space with industry-leading sound reduction for when you need to block everything out. It is a perfect fit for **focused work** sessions, **private conversations**, and **meetings** with **two to four-person** capacity.

**S2 acoustic booth** is also the **basic modular unit** of this **flexible** product line. By adding more units, it allows you to **create bigger models** with larger capacities.

\* Furniture not included

## Flexible Setups



○ Silver Grey exterior

### Private Workplace

A versatile and adaptable one-person height-adjustable workstation with a comfortable modular sofa.



○ Cotton exterior

### Meeting Room

An ideal setting for up to 4 people, ensuring confidential conversations and meetings remain undisturbed.



● Blue Tiber exterior

### Video Call Booth

A private remote workspace with integrated table and TV screen for video calls and brief work sessions.

- Modular flexibility
- Wheels included
- Sound insulation
- LED
- Acoustic panels
- Automated air circulation
- 2 x 110V + 2 x USB



# Measurements

## Space 2

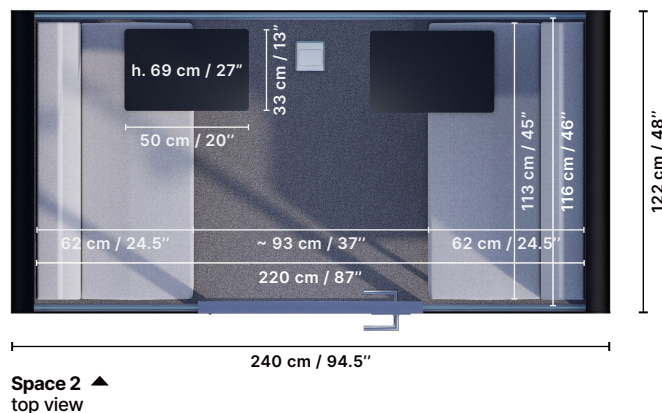
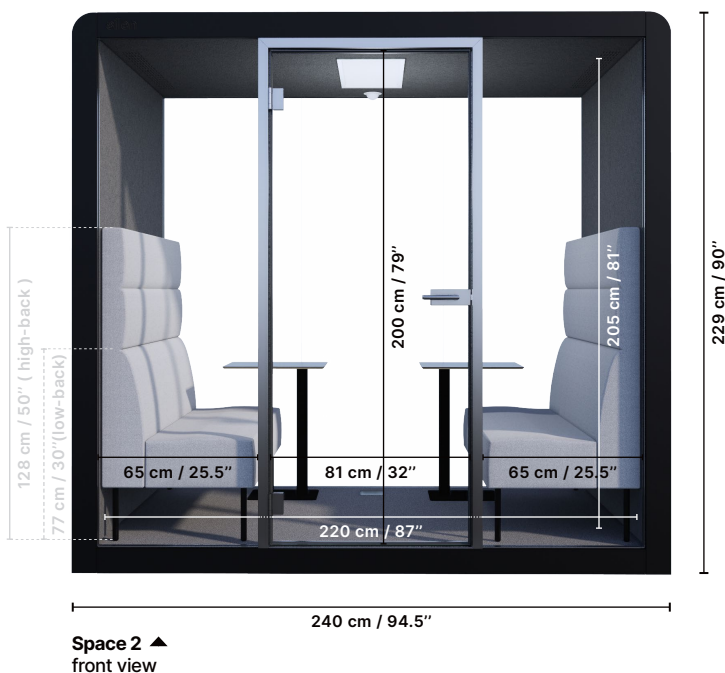

### Space 2 Meeting Room

Furnished with set of Vega high-back sofas & Gaia laptop tables.

Interior floor area  
2.6 sqm / 27.5 sqft

## Specification

### Size

Exterior: W cm/in, H cm/in, D cm/in  
240/94    229/90    122/48

Interior: W cm/in, H cm/in, D cm/in  
220/87    205/81    116/46

### Weight

670 kg / 1477 lb

### Door

Left or Right

### Lighting

LED light; 4000K (3000K per request)  
with motion sensor; energy-efficient

### Power connection

Through the floor or ceiling;  
plug to 15 Amp power outlet

### Additional pod features

- Automatic door operator and push-to-open buttons
- Silen Dynamics Generation: easily exchangeable side skins
- Quest fabric selection for exterior walls only

### Wall, Ceiling

EchoFree acoustic panels

### Floor

Antistatic, stain resistant carpet for public spaces

### Glass

6+6 mm acoustic laminated sound control glass

### Air ventilation

Low power consumption 6.8W air circulation system ( speed - 85l/s; full air exchange time ~62s)

### Casters

For easy relocation

### Adjustable legs

For leveling and stability

## Finish selections

### Profiles / Door frame



### Hinges / Door handle



### Interior colours



### Exterior colours



### Additional colours



### Veneer finishes



click to  
**Configure S2**

**ASTM E84**  
CLASS A

acoustics  
**43 STC**

**UL** LISTED  
US UL 962

**CERTIFIED**  
**CARBON**  
**NEUTRAL**  
product

**CERTIFIED**  
ENVIRONMENTALLY  
PREFERABLE PRODUCT  
GREEN SOURCE

## Available Add-ons for Space 2



### Private Lounge

- **Integrated table** (height: 730mm/29" | table top: white; 600×740mm)
- **Integrated swivel screen bracket** (+VESA mount)
- **Additional power socket 2×110V + USB charging ports** (under the table)
- **Air flow and lighting dimmer**
- **Vega low-back modular sofa** (set)
- **Textile sides** (Quest fabric selection)

- Azurite cover trims
- Tide textile sides
- Dark Grey interior
- Black profiles



### Quiet Workspace

- **Height-adjustable table** (height: min 700mm, max 1150mm | table top: white; 1100×550mm)
- **Additional wall-integrated power socket 110V + USB charging ports**
- **Swivel office chair** (externally sourced)
- **Integrated storage unit** (850×400×290mm | white laminate; plywood edge | shelves and 2 drawers)
- **Occupancy indicator light**

- Black exterior
- Black interior
- White profiles



### Video Conference Pod

- **Universal screen bracket** (on right side wall)
- **Additional wall integrated power socket 110V + USB charging ports**
- **Gaia movable laptop tables** (height: 690mm/27.5")
- **Vega high-back modular sofa**
- **Lightweight swivel stool** (externally sourced)
- **Air flow and lighting dimmer**
- **Veneer exterior finish**

- Oak Veneer exterior
- Light Grey interior
- Grey/Aluminum profiles



In-person meetings



Focused work



Virtual meetings

# Get Inspired with Space 2



<sup>1</sup> Wall screen mount, Vega low-back modular sofa + Gaia movable laptop table



<sup>2</sup> Vega high-back modular sofa sets, integrated tables + integrated screen mounts

scan for  
**Space 2 AR**



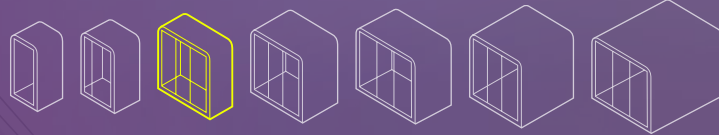

## Space 2.5

Silent room for up to 6 people.

### BIGGER SPACE FOR MORE COMFORT

Space 2.5 is a versatile and movable interior space element that creates a high focus work area within a noisy office space. It is ideal for concentrated work sessions, private conversations, and meetings for up to six people.

Moreover, the S2.5 booth offers bigger space than the S2 pod, providing increased furniture variations and flexibility. S2.5 is modular, hence you can construct larger rooms to expand your booth capacity.

\* Furniture not included

## Flexible Setups



— Oak Veneer exterior

### Video Call Space

Movable soundproof booth with an integrated screen for video calls, remote work, and collaboration.



— Coal exterior

### Meeting Booth



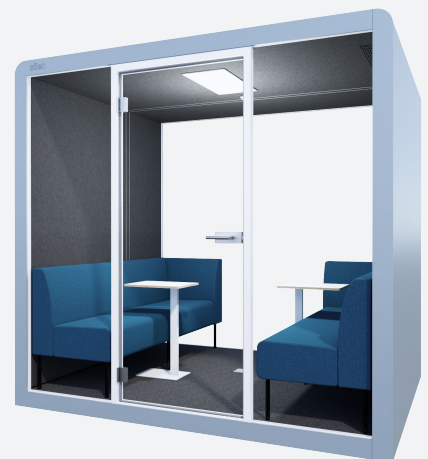



Flexible meeting and conference room setup with a glass-mounted screen and table for up to 6 people.



— Frozen Blue

### Private Lounge

An even more spacious acoustic office pod, perfect for confidential conversations and focused work.

-  Modular flexibility
-  Wheels included
-  Sound insulation
-  LED
-  Acoustic panels
-  Automated air circulation
-  2 x 110V + 2 x USB

# Measurements

## Space 2.5



Space 2.5 ▲  
front view

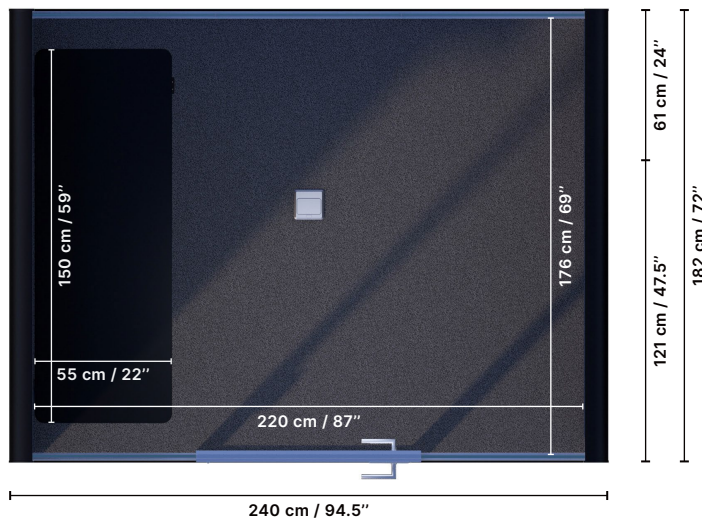

Space 2.5 ▲  
top view

### Space 2.5 Workstation

Furnished with built-in height-adjustable table.

Interior floor area  
3.9 sqm / 41.7 sqft

## Specification

### Size

Exterior: W cm/in, H cm/in, D cm/in  
240/94 229/90 182/72

Interior: W cm/in, H cm/in, D cm/in  
220/87 205/81 176/69

### Weight

848.5 kg / 1871 lb

### Door

Left or Right

### Lighting

LED light; 4000K (3000K per request)  
with motion sensor; energy-efficient

### Power connection

Through the floor or ceiling;  
plug to 15 Amp power outlet

### Additional pod features

- Automatic door operator and push-to-open buttons
- Silen Dynamics Generation: easily exchangeable side skins
- Quest fabric selection for exterior walls only

### Wall, Ceiling

EchoFree acoustic panels

### Floor

Antistatic, stain resistant carpet for public spaces

### Glass

6+6 mm acoustic laminated sound control glass

### Air ventilation

Low power consumption 13.6W air circulation system (speed - 110l/s; full air exchange time ~72s)

### Casters

For easy relocation

### Adjustable legs

For leveling and stability

## Finish selections

### Profiles / Door frame



### Hinges / Door handle



### Interior colours



### Exterior colours

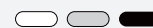

### Additional colours



### Veneer finishes



ASTM E84  
CLASS A

acoustics  
43 STC

UL LISTED  
US UL 962

CERTIFIED  
CARBON  
NEUTRAL  
product

CERTIFIED  
ENVIRONMENTALLY  
PRESERVABLE PRODUCT  
GLOBAL SOURCE

## Available Add-ons for Space 2.5



### Video Call Lounge

- Universal screen bracket (on left side wall)
- Additional wall-integrated **power socket 110V + USB charging ports**
- Gaia movable laptop tables (height: 690mm/27.5")
- Vega low-back corner modular sofa
- Air flow and lighting dimmer
- Extra colour laminate

- Mint exterior
- Dark Grey interior
- Black profiles



### Quiet Workstation

- Height-adjustable table (height: min 700mm, max 1150mm | table top: white; 1500×550mm)
- Additional wall-integrated **power socket 110V + USB charging ports**
- Swivel office chair (externally sourced)
- Vega low-back modular sofa
- Occupancy indicator light
- Air flow and lighting dimmer
- Extra colour laminate

- Opal exterior
- Black interior
- White profiles

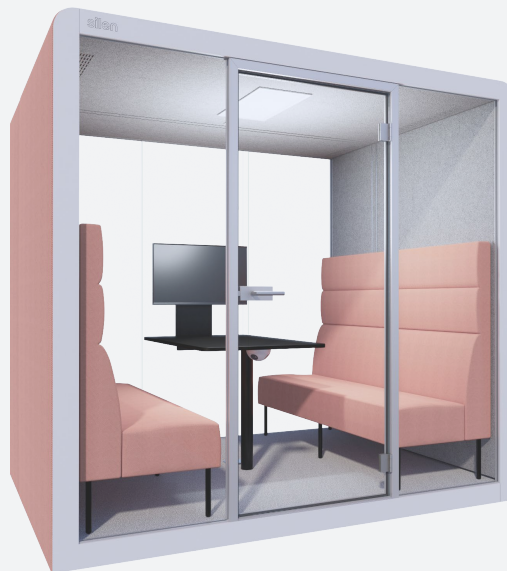

### Meeting Space

- Integrated table (height: 730mm/29" | table top: black; 1200×740mm)
- Integrated swivel screen bracket (+VESA mount)
- Additional **power socket 2×110V + USB charging ports** (under the table)
- Vega high-back modular sofa
- Textile sides (Quest fabric selection)

- Silver Grey cover trims
- Shrimp textile sides
- Light Grey interior
- Grey/Aluminum profiles



Virtual meetings



Focused work



In-person meetings

# Get Inspired with Space 2.5



<sup>1</sup> Height-adjustable desks + Vega low-back modular sofas



<sup>2</sup> Vega low-back modular sofa set, integrated table + integrated screen mount

scan for Space 2.5 AR





## Space 4

Silent room for up to 8 people.

### MORE SPACE FOR IDEAS

**Space 4** spaciouly fits **four people** and cozily **eight** for an efficient **brainstorming session**, **remote work**, video **calls**, or for a **longer meeting** that requires everyone to be on the same wavelength.

The **modular** structure means that you can quickly **change** your **Space size** when you need it. **Add** more **modules** to upgrade your booth capacity for as many people as you like or **split** S4 acoustic room into **two** separate S2 **units**.

\* Furniture not included

## Flexible Setups



Orange exterior

### Meeting Lounge

Corner sofa configuration with laptop tables and wall-mounted TV screen, perfect for meetings and presentations.



Blue Tiber exterior

### Private Office







Single-person workstation with room to lounge and meet includes height-adjustable table and integrated screen.



Jade exterior

### Team Workspace

Acoustic room designed for private discussions, team brainstorming, and collaborative work for up to 6 people.

-  Modular flexibility
-  Wheels included
-  Sound insulation
-  LED
-  Acoustic panels
-  Automated air circulation
-  4 x 110V + 4 x USB



# Measurements

## Space 4

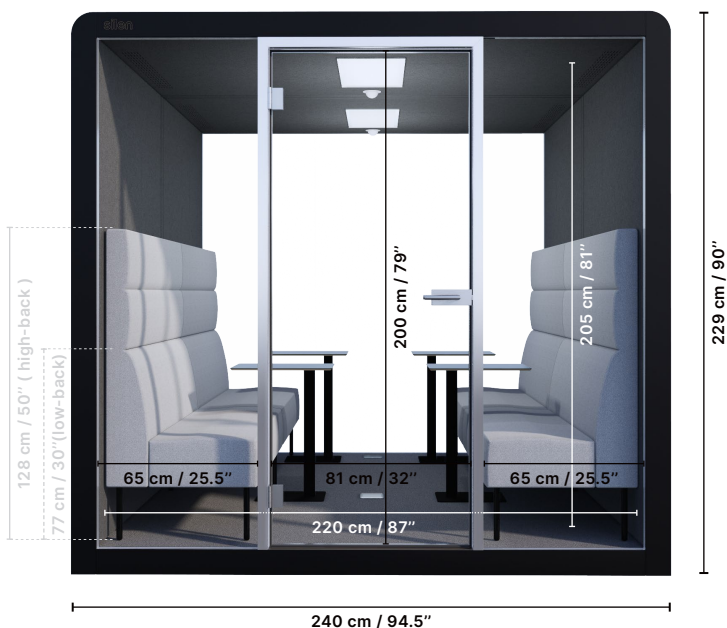

Space 4 ▲  
front view

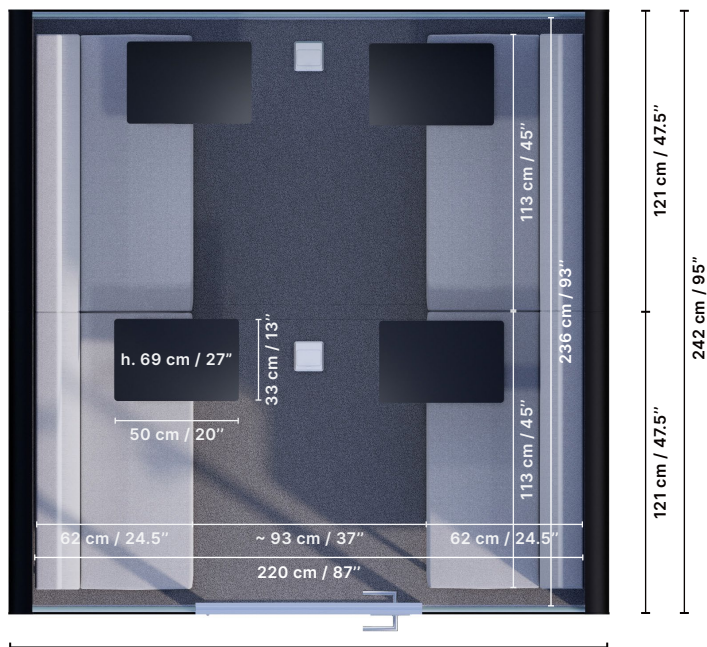

Space 4 ▲  
top view

## Space 4 Meeting Room

Furnished with 2 sets of Vega high-back sofas & Gaia laptop tables.

Interior floor area  
5.2 sqm / 55.9 sqft

## Specification

### Size

Exterior: W cm/in, H cm/in, D cm/in  
240/94 229/90 242/95

Interior: W cm/in, H cm/in, D cm/in  
220/87 205/81 236/93

### Weight

1200 kg / 2646 lb

### Door

Left or Right

### Lighting

LED light; 4000K (3000K per request)  
with motion sensor; energy-efficient

### Power connection

Through the floor or ceiling;  
plug to 15 Amp power outlet

### Additional pod features

- Automatic door operator and push-to-open buttons
- Silen Dynamics Generation: easily exchangeable side skins
- Quest fabric selection for exterior walls only

### Wall, Ceiling

EchoFree acoustic panels

### Floor

Antistatic, stain resistant carpet for public spaces

### Glass

6+6 mm acoustic laminated sound control glass

### Air ventilation

Low power consumption 13.6W air circulation system (speed - 125l/s; full air exchange time ~85s)

### Casters

For easy relocation

### Adjustable legs

For leveling and stability

## Finish selections

### Profiles / Door frame



### Hinges / Door handle

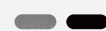

### Interior colours

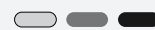

### Exterior colours

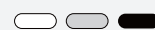

### Additional colours



### Veneer finishes



click to  
**Configure S4**

**ASTM E84**  
CLASS A

acoustics  
**41 STC**

**UL** LISTED  
US UL 962

**CERTIFIED**  
**CARBON**  
**NEUTRAL**  
product

**CERTIFIED**  
ENVIRONMENTALLY  
PRESERVABLE PRODUCT  
GLOBAL SOURCE

## Available Add-ons for Space 4



### Meeting Space

- Screen bracket on back glass (+VESA mount)
- Gaia movable laptop tables (height: 690mm/27.5")
- Vega low-back modular sofa (2 sets)
- Power sockets 110V + USB charging ports
- Air flow and lighting dimmer
- Frosted film on a glass
- Extra colour laminate

- Paprika exterior
- Light Grey interior
- Grey/Aluminum profiles



### Conference Room

- Integrated table (height: 730mm/29" | table top: white; 1820×740mm)
- Integrated swivel screen bracket (+VESA mount)
- Additional power sockets 2×110V + USB charging ports (under the table)
- 4 swivel office chairs (externally sourced)
- Occupancy indicator light
- Textile sides (Quest fabric selection)

- Storm Grey cover
- Sea Foam textile sides
- Dark Grey interior
- Black profiles



### Private Workspace

- Swivel screen bracket (on right side wall)
- Height-adjustable table (height: min 700mm, max 1150mm | table top: white; 1100×550mm)
- Height-adjustable task chair (externally sourced)
- Additional wall-integrated power sockets 110V + USB charging ports
- Gaia movable laptop tables (height: 690mm/27.5")
- Vega low-back corner modular sofa (set)
- Magnetic whiteboard (1270×710mm)

- Light Grey exterior
- Black interior
- White profiles



Group meetings



Project presentations



Focused work

# Get Inspired with Space 4



<sup>1</sup> Vega high-back modular sofa sets + Gaia movable laptop tables



<sup>2</sup> Vega low-back modular sofa, wall screen mount + height-adjustable table

scan for  
**Space 4 AR**



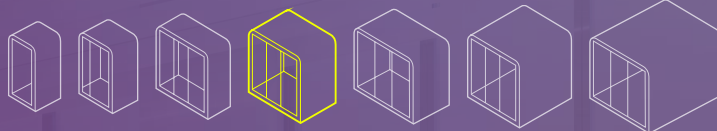

## Space 4.5

Silent room for up to 10 people.

### LARGER BOOTH FOR A TEAM

**Space 4.5** is extended variant of the S4 booth, offering ample room to accommodate up to **ten people**. This expanded capacity provides excellent opportunities for **team meetings**, video **conferencing**, or simply for **working in privacy**.

**S4.5 booth** is designed to be **flexible** and **movable**, allowing you to **adjust its size** and appearance according to your changing needs. It serves as a **modular solution** that empowers you to **create your own Spaces**.

\* Furniture not included

## Flexible Setups



■ Azurite exterior

### Team Workspace

Acoustic booth for uninterrupted work and private conversations with built-in table and glass mounted TV screen.



○ Silver Grey exterior

### Presentation Pod

Spacious interior setup with a corner sofa and movable laptop tables, suitable for remote work and presentations.



■ Frozen Blue exterior

### Meeting Lounge

The wrap-around sofa layout optimizes booth capacity, providing an excellent setting for meetings and discussions.



Modular flexibility



Wheels included



Sound insulation



LED



Acoustic panels



Automated air circulation



4 x 110V + 4 x USB

# Measurements

## Space 4.5

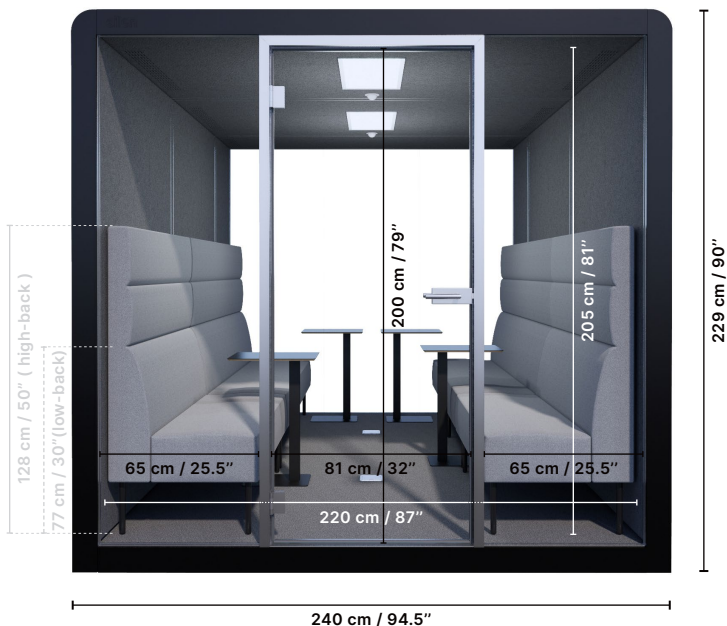

Space 4.5 ▲  
front view

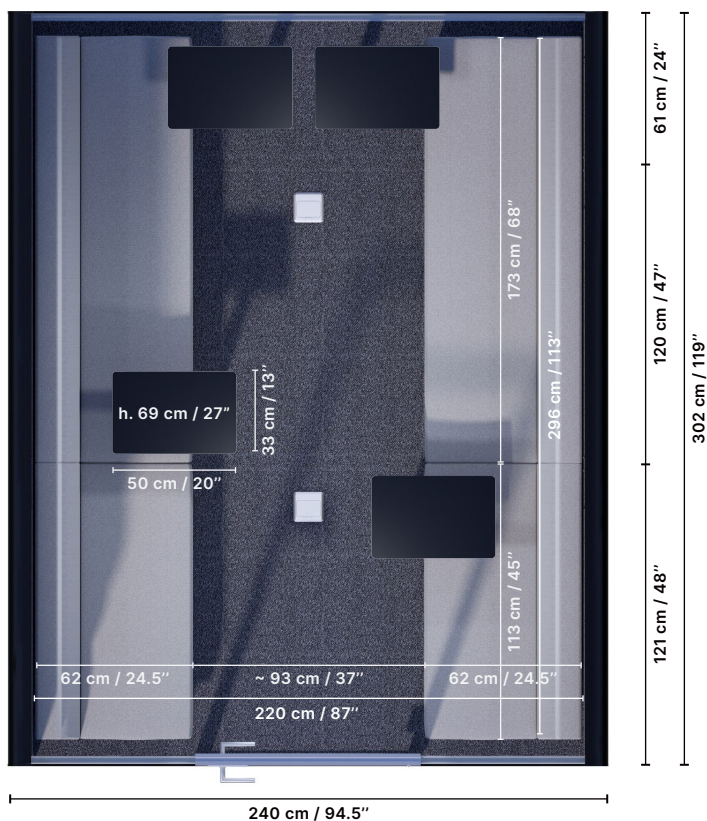

Space 4.5 ▲  
top view

**Interior floor area**  
6.5 sqm / 70.1 sqft

### Space 4.5 Meeting Room

Furnished with 2 sets of Vega high-back sofas & Gaia laptop tables.

## Specification

### Size

Exterior: W cm/in, H cm/in, D cm/in  
240/94 229/90 302/118

Interior: W cm/in, H cm/in, D cm/in  
220/87 205/81 296/117

### Weight

1378.5 kg / 3039 lb

### Door

Left or Right

### Lighting

LED light; 4000K (3000K per request)  
with motion sensor; energy-efficient

### Power connection

Through the floor or ceiling;  
plug to 15 Amp power outlet

### Additional pod features

- Automatic door operator and push-to-open buttons
- Silen Dynamics Generation: easily exchangeable side skins
- Quest fabric selection for exterior walls only

### Wall, Ceiling

EchoFree acoustic panels

### Floor

Antistatic, stain resistant carpet for public spaces

### Glass

6+6 mm acoustic laminated sound control glass

### Air ventilation

Low power consumption 20.4W air circulation system (speed - 140l/s; full air exchange time ~95s)

### Casters

For easy relocation

### Adjustable legs

For leveling and stability

## Finish selections

### Profiles / Door frame



### Hinges / Door handle



### Interior colours

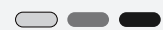

### Exterior colours

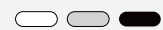

### Additional colours



### Veneer finishes



## Available Add-ons for Space 4.5



### Video Conference Booth

- Universal screen bracket (on right side wall)
- Additional wall-integrated power socket 110V + USB charging ports
- Gaia movable laptop tables (height: 690mm/27.5")
- Vega low-back corner modular sofa
- Air flow and lighting dimmer
- Textile sides (Quest fabric selection)

- Deer cover trims
- Fossil textile sides
- Dark Grey interior
- Grey/Aluminum profiles



### Quiet Boardroom

- Integrated table (height: 730mm/29" | table top: white; 1820×740mm)
- Integrated swivel screen bracket (+VESA mount)
- Additional power sockets 2×110V + USB charging ports (under the table)
- 4 swivel office chairs (externally sourced)
- Occupancy indicator light
- Extra colour laminate

- Cotton exterior
- Black interior
- White profiles



### Private Office

- Swivel screen bracket (on right side wall)
- Additional-wall integrated power socket 110V + USB charging ports
- Height-adjustable table (height: min 700mm, max 1150mm | table top: black; 1700×550mm)
- Height-adjustable task chair (externally sourced)
- Gaia movable laptop tables (height: 690mm/27.5")
- Vega low-back modular sofa (set)
- Airflow and lighting dimmer
- Extra colour laminate

- Jade exterior
- Light Grey interior
- Black profiles



Virtual meetings



Group meetings



Focused work

# Get Inspired with Space 4.5



<sup>1</sup> Integrated tables, office chairs + screen mounts



<sup>2</sup> Vega high-back corner sofa set + Gaia movable laptop tables

scan for  
**Space 4.5 AR**





## Space 6

Silent room for up to 12 people.

### FOR THINKING BIG

**Space 6** offers an exceptionally **spacious interior** that effectively **eliminates** almost all **outside distractions**. This makes the S6 acoustic room perfect for both **individuals** seeking uninterrupted creativity and **teams** ready to embark on wild idea expeditions.

This **soundproof pod** provides plenty of space for a wide range of activities - **team meetings, project presentations, video conferencing, private conversations, and uninterrupted work.**

\* Furniture not included

## Flexible Setups

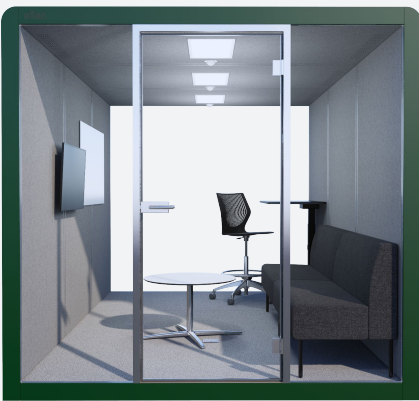

Eden exterior

### Full-sized Office

Complex height-adjustable workspace with a whiteboard and lounge seating, suitable for work and meetings.



Basalt exterior

### Private Lounge

Quiet meeting room equipped with lounge seating and TV screen for longer conversations and video conferencing.



Orange exterior

### Acoustic Boardroom

Acoustic space featuring a built-in table and 7 task chairs, ideal for collaborative work and team brainstorming.



Modular flexibility



Wheels included



Sound insulation

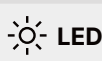

LED



Acoustic panels



Automated air circulation

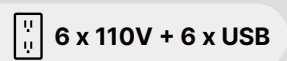

6 x 110V + 6 x USB



# Measurements

## Space 6

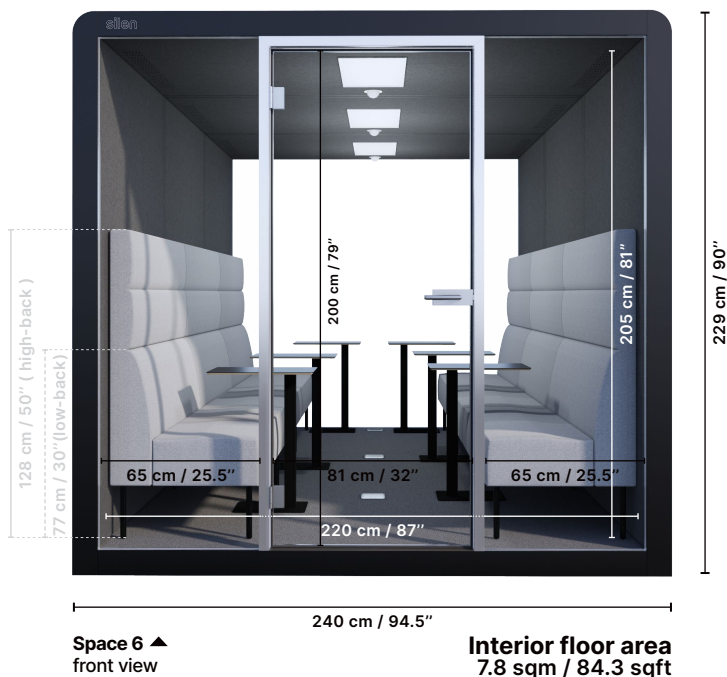

## Space 6 Meeting Room

Furnished with 3 sets of Vega high-back sofas & Gaia laptop tables.

Space 6 top view

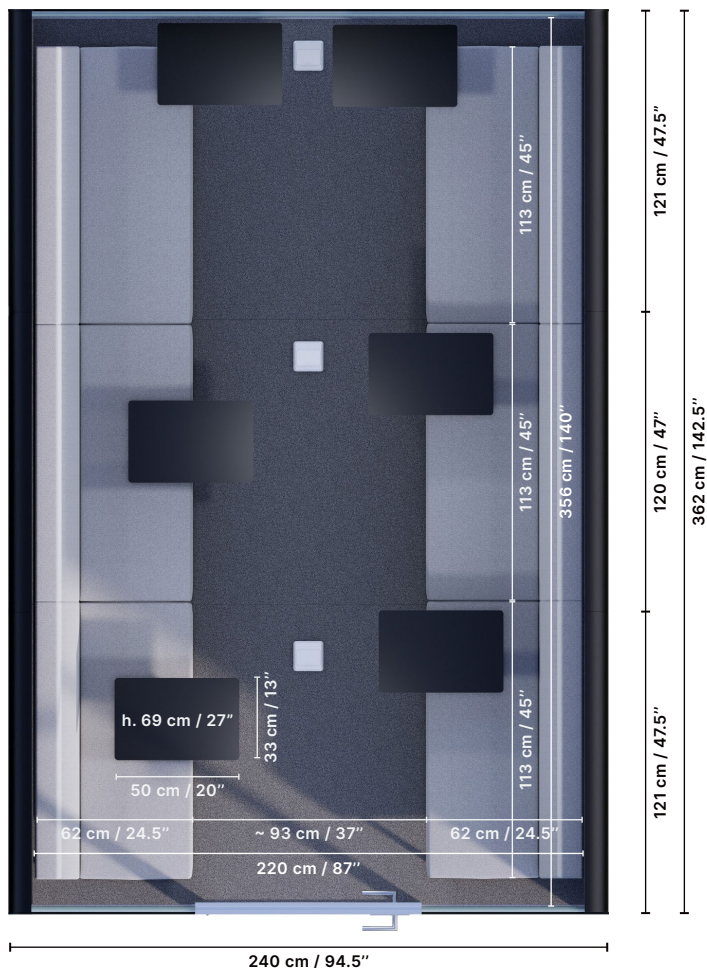

# Specification

## Size

Exterior: W cm/in, H cm/in, D cm/in  
240/94 229/90 362/143

Interior: W cm/in, H cm/in, D cm/in  
220/87 205/81 356/140

## Weight

1730 kg / 3814 lb

## Door

Left or Right

## Lighting

LED light; 4000K (3000K per request)  
with motion sensor; energy-efficient

## Power connection

Through the floor or ceiling;  
plug to 15 Amp power outlet

## Additional pod features

- Automatic door operator and push-to-open buttons
- Silen Dynamics Generation: easily exchangeable side skins
- Quest fabric selection for exterior walls only

## Wall, Ceiling

EchoFree acoustic panels

## Floor

Antistatic, stain resistant carpet for public spaces

## Glass

6+6 mm acoustic laminated sound control glass

## Air ventilation

Low power consumption 20.4W air circulation system (speed - 180l/s; full air exchange time ~89s)

## Casters

For easy relocation

## Adjustable legs

For leveling and stability

# Finish selections

## Profiles / Door frame



## Hinges / Door handle



## Interior colours



## Exterior colours



## Additional colours



## Veneer finishes



click to  
**Configure S6**

**ASTM E84**  
CLASS A

acoustics  
**41 STC**

**UL** LISTED  
US UL 962

**CERTIFIED**  
**CARBON**  
**NEUTRAL**  
product

**CERTIFIED**  
ENVIRONMENTALLY  
PRESERVABLE PRODUCT  
GLOBAL SOURCE

## Available Add-ons for Space 6



### Conference Room

- Universal screen brackets (on left & right side walls)
- Additional wall-integrated power sockets 110V + USB charging ports
- Integrated table (height: 730mm/29" | table top: black; 1820×740mm)
- Additional power socket 2×110V + USB charging ports (under the table)
- 6-8 task chairs (externally sourced)
- Front and back door for easy access
- Textile sides (Quest fabric selection)

- Storm Grey cover trims
- Bernacle textile sides
- Black interior
- Grey/Aluminum profiles



### Presentation Space

- Swivel screen bracket
- Additional wall-integrated power sockets 110V + USB charging ports
- Magnetic whiteboards (1270×710mm)
- Gaia movable laptop tables (height: 690mm/27.5")
- Vega low-back corner modular sofa
- Lightweight swivel stools (externally sourced)
- Air flow and lighting dimmer
- Extra colour laminate

- Bambus exterior
- Light Grey interior
- Black profiles



### Quiet Workspace

- Screen bracket on back glass (+VESA mount)
- Gaia movable laptop tables (height: 690mm/27.5")
- Vega high-back modular sofa (2 sets)
- Height-adjustable table (height: min 700mm, max 1150mm | table top: black; 1100×550mm)
- Swivel office chair (externally sourced)
- Additional wall integrated power socket 110V + USB charging ports
- Side door option
- Extra colour laminate

- Mint exterior
- Dark Grey interior
- Black profiles



Group meetings



Project presentations



Focused work

# Get Inspired with Space 6



<sup>1</sup> Vega corner sofa configuration, Gaia movable laptop tables, wall screen mount + whiteboard



<sup>2</sup> Meeting booth / Conference room setup

scan for  
**Space 6 AR**



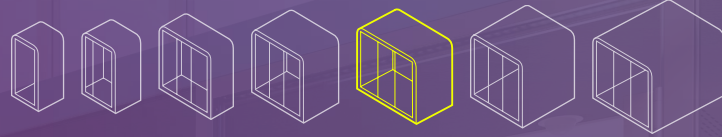

## Space Max

Silent room for up to 8 people.

### SPACIOUS MEETING POD

This **extra-large acoustic booth** based on a smaller Space 4 model has **bigger** inside space, providing enough room for up to **eight people**.

**Extended interior** width brings more space for even more **variable** usage and furniture setups. It is recommended to use SMax as a spacious **meeting pod, conference room** or **private office**. Such as other Silen pods, **Space Max** is also **modular and movable**.

\* Furniture not included

## Flexible Setups



Myosotis exterior

### Presentation Lounge

Spacious meeting lounge suitable for private work, business meetings, or confidential conversations.



Mango exterior

### Meeting Booth

Large co-working space capable of accommodating creative ideas during team meetings for up to 7 people.



Silver Grey exterior

### Quiet Workspace

Acoustic office booth with a height-adjustable workstation and room for meetings or project presentations.

- Modular flexibility
- Wheels included
- Sound insulation
- LED
- Acoustic panels
- Automated air circulation
- 2 x 110V + 2 x USB

# Measurements

## Space Max

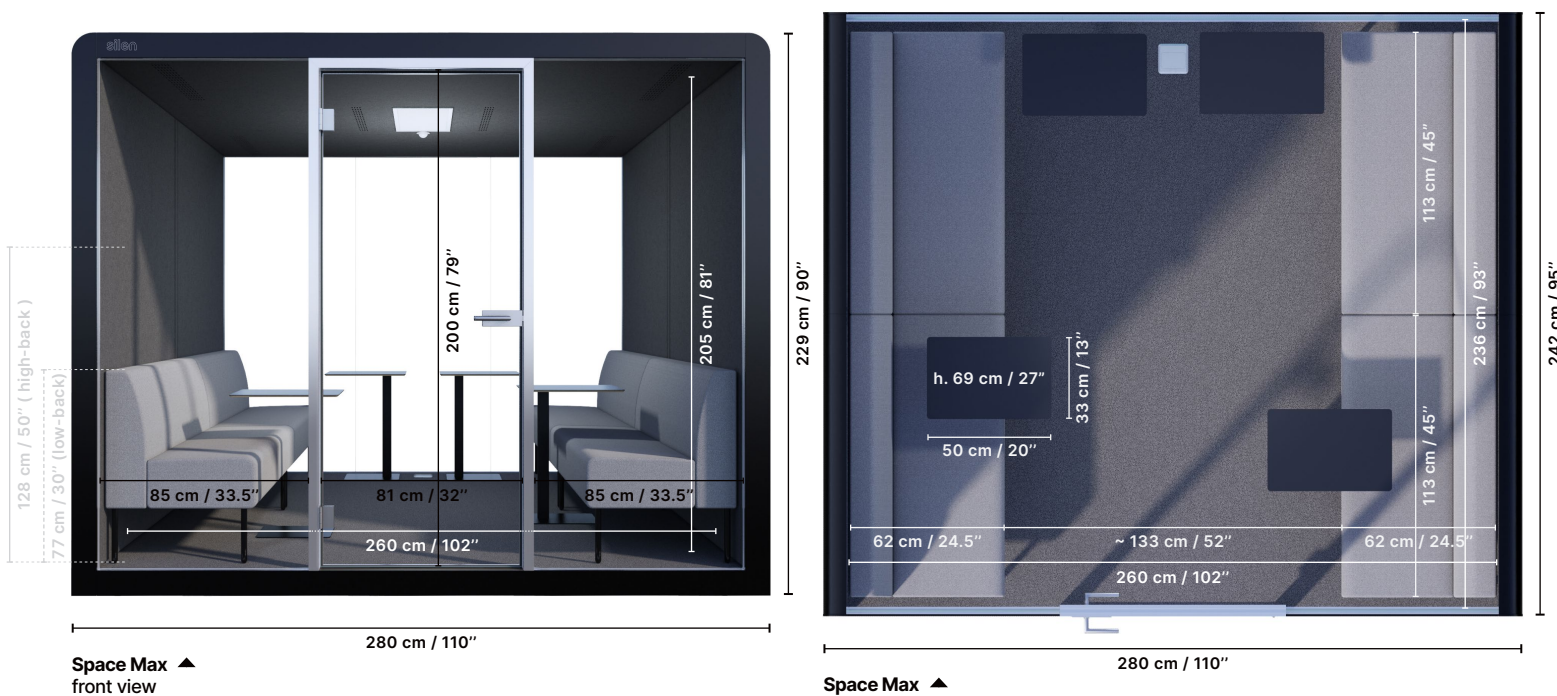

## Space Max Meeting Room

Furnished with 2 sets of Vega low-back sofas & Gaia laptop tables.

**Interior floor area**  
6.1 sqm / 66.1 sqft

## Specification

### Size

Exterior: W cm/in, H cm/in, D cm/in  
280/110 229/90 242/95

Interior: W cm/in, H cm/in, D cm/in  
260/102 205/81 236/93

### Weight

1500 kg / 3307 lb

### Door

Left or Right

### Lighting

LED light; 4000K (3000K per request)  
with motion sensor; energy-efficient

### Power connection

Through the floor or ceiling;  
plug to 15 Amp power outlet

### Additional pod features

- Automatic door operator and push-to-open buttons
- Silen Dynamics Generation: easily exchangeable side skins
- Quest fabric selection for exterior walls only

### Wall, Ceiling

EchoFree acoustic panels

### Floor

Antistatic, stain resistant carpet for public spaces

### Glass

6+6 mm acoustic laminated sound control glass

### Air ventilation

Low power consumption 17W air circulation system (speed - 155l/s; full air exchange time ~81s)

### Casters

For easy relocation

### Adjustable legs

For leveling and stability

## Finish selections

### Profiles / Door frame



### Hinges / Door handle



### Interior colours

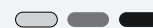

### Exterior colours

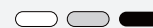

### Additional colours



### Veneer finishes



click to  
**Configure SMax**

**ASTM E84**  
CLASS A

acoustics  
**40 STC**

**UL** LISTED  
US UL 962

**CERTIFIED**  
**CARBON**  
**NEUTRAL**  
product

**CERTIFIED**  
ENVIRONMENTALLY  
PRESERVABLE PRODUCT  
GLOBAL SOURCE

## Available Add-ons for Space Max



### Meeting Room

- **Magnetic whiteboard** (2000×1000mm) with **universal screen bracket**
- **Integrated table** (height: 730mm/29" | table top: white; 2000×900mm)
- **4-6 office chairs** (externally sourced)
- Additional wall integrated **power sockets 110V + USB charging ports + HDMI**
- **Front and back door for easy access**
- **Extra colour laminate**

- **Bambus exterior**
- **Light Grey interior**
- **Grey/Aluminum profiles**



### Video Call Space

- **Screen bracket on back glass** (+VESA mount)
- **Gaia movable laptop tables** (height: 690mm/27.5")
- **Vega low-back modular sofa** (2 sets)
- **Lightweight stools** (externally sourced)
- **Air flow and lighting dimmer**
- **Extra colour laminate**

- **Jade exterior**
- **Dark Grey interior**
- **Black profiles**



### Private Office

- **Universal screen bracket** (on right side wall)
- Additional wall-integrated **power sockets 110V + USB charging ports**
- **Gaia movable laptop tables** (height: 690mm/27.5")
- **Vega high-back modular sofa** (set)
- **Height-adjustable table** (height: min 700mm, max 1150mm | table top: black; 1100×550mm)
- **Height-adjustable task chair** (externally sourced)
- **Occupancy indicator light**
- **Textile sides** (Quest fabric selection)

- **Black cover trims**
- **Tide textile sides**
- **Black interior**
- **Black profiles**



Creative sessions



Group meetings



Focused work

# Get Inspired with Space Max



<sup>1</sup> Wall screen mount + integrated conference table



<sup>2</sup> Vega wrap-around sofa configuration + Gaia movable laptop tables

scan for  
**Space Max AR**





## Space Max 2X

Silent room for up to 16 people.

### LARGEST ACOUSTIC ROOM

Double extra-large booth for those who depend on large creative team meetings for up to **sixteen people**. Two **Space Max modules** connected to one, form a **spacious acoustic pod** that can be used as a **conference room, private office, or presentation space**.

The biggest **acoustic room** brings **endless possibilities to configure** and achieve the most **multifunctional** use of your **Space Max 2X** office pod.

\* Furniture not included

## Flexible Setups



Basalt exterior

### Executive Suite

Quiet acoustic office space perfect for uninterrupted work sessions, meetings, and confidential discussions.



Mango exterior

### Presentation Room

Spacious meeting pod configuration with integrated power outlets and adjustable TV stand for project presentations.



Marshmallow exterior

### Meeting Space

Private meeting room with a capacity for 10 people, ideal for group meetings, conversations, or team brainstorming.

- Modular flexibility
- Wheels included
- Sound insulation
- LED
- Acoustic panels
- Automated air circulation
- 4 x 110V + 4 x USB



# Measurements

## Space Max 2X



Space Max 2X ▲  
front view

**Interior floor area**  
12.4 sqm / 133.2 sqft

## Space Max 2X Meeting Room

Furnished with 4 sets of Vega low-back sofas & Gaia laptop tables.

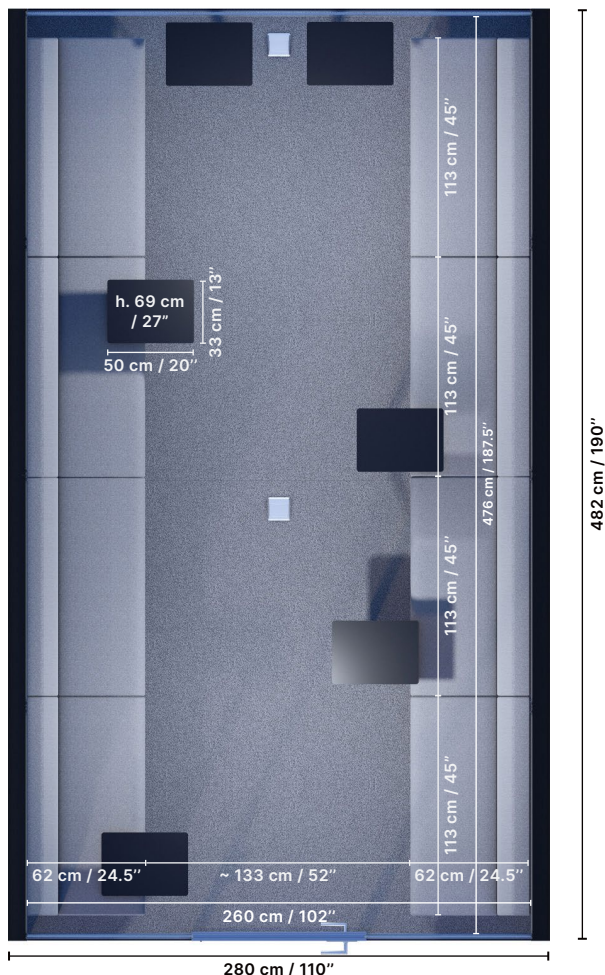

Space Max 2X ▶  
top view

# Specification

### Size

Exterior: W cm/in, H cm/in, D cm/in  
280/110 229/90 482/190

Interior: W cm/in, H cm/in, D cm/in  
260/102 205/81 476/188

### Weight

2600 kg / 5732 lb

### Door

Left or Right

### Lighting

LED light; 4000K (3000K per request) with motion sensor; energy-efficient

### Power connection

Through the floor or ceiling; plug to 15 Amp power outlet

### Additional pod features

- Automatic door operator and push-to-open buttons
- Silen Dynamics Generation: easily exchangeable side skins
- Quest fabric selection for exterior walls only

### Wall, Ceiling

EchoFree acoustic panels

### Floor

Antistatic, stain resistant carpet for public spaces

### Glass

6+6 mm acoustic laminated sound control glass

### Air ventilation

Low power consumption 34W air circulation system (speed - 263l/s; full air exchange time ~96s)

### Casters

For easy relocation

### Adjustable legs

For leveling and stability

# Finish selections

### Profiles / Door frame



### Hinges / Door handle



### Interior colours



### Exterior colours

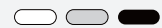

### Additional colours



### Veneer finishes



click to  
**Configure SMax 2X**

**ASTM E84**  
CLASS A

acoustics  
**40 STC**

**UL** LISTED  
US UL 962

**CERTIFIED**  
**CARBON**  
**NEUTRAL**  
product

**CERTIFIED**  
ENVIRONMENTALLY  
PRESERVABLE PRODUCT  
GREENGUARD  
GREENGUARD  
GREENGUARD

## Available Add-ons for Space Max 2X



### Team Pod

- Height-adjustable tables (height: min 700mm, max 1150mm | table top: black; 1100×550mm)
- Height-adjustable chairs (externally sourced)
- Gaia movable laptop tables (height: 690mm/27.5")
- Vega low-back modular sofa (2 sets)
- Additional wall integrated power sockets 110V + USB charging ports
- Extra colour laminate

- Blue Tiber exterior
- Dark Grey interior
- Black profiles



### Boardroom

- Integrated tables (height: 730mm/29" | table top: white; 2× 2000×900mm)
- Additional power socket 2×110V + USB charging ports (under the table)
- 8-10 swivel office chairs (externally sourced)
- Additional wall integrated power sockets 110V + USB charging ports
- Airflow and lighting dimmer
- Front and back door for easy access
- Textile sides (Quest fabric selection)

- Deer cover trims
- Salt textile sides
- Dark Grey interior
- Grey/Aluminum profiles



### Classroom

- Universal screen bracket
- Magnetic whiteboards (1270×710mm)
- Additional wall-integrated power socket 110V + USB charging ports
- Free-standing table (externally sourced)
- Height-adjustable chair (externally sourced)
- Task chairs with tablet table (externally sourced)
- Additional wall-integrated power sockets 110V + USB charging ports
- Side door option
- Extra colour laminate

- Frozen Blue exterior
- Light Grey interior
- White profiles



Focused work



Group meetings



Trainings & classes

# Get Inspired with Space Max 2X



<sup>1</sup> Vega low-back modular sofa with armrests, wall screen mount + two door



<sup>2</sup> Executive suite: Vega low-back modular sofa, Gaia movable laptop tables, wall screen mounts, whiteboards + integrated conference tables

scan for  
**Space Max 2X AR**





## Workstation Hybrid

Work pod for one person.

### THE PERFECT GETAWAY IN AN OPEN OFFICE

As the **smallest** in the **Space Hybrid** range, the **Workstation Hybrid** offers a solitary work environment. It accommodates one person and features an electrically height-adjustable table, providing a quiet space for **focused work** in an open office setting.

Hybrid booths incorporate standard Silen Space **acoustic features and materials**, along with the inclusion of a **low doorstep** and other optional add-ons. **Workstation Hybrid** is **accessible and barrier-free**.

\* Furniture not included

## Flexible Setups

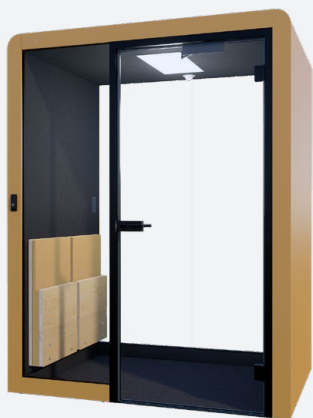

Deer exterior

### Private Room

One-person acoustic office booth for private calls with set of folding chairs and accessibility for everyone.



Opal exterior

### Video Conference Pod

Flexible room with folding chairs and a wall screen mount for confidential video conferencing sessions.



Frozen Blue exterior

### Quiet Workstation

Private workstation furnished with a built-in height-adjustable desk and barrier-free access.



Low  
doorstep



Sound  
insulation



LED



Acoustic  
panels



Automated air  
circulation



110V + USB

# Measurements

## Workstation Hybrid

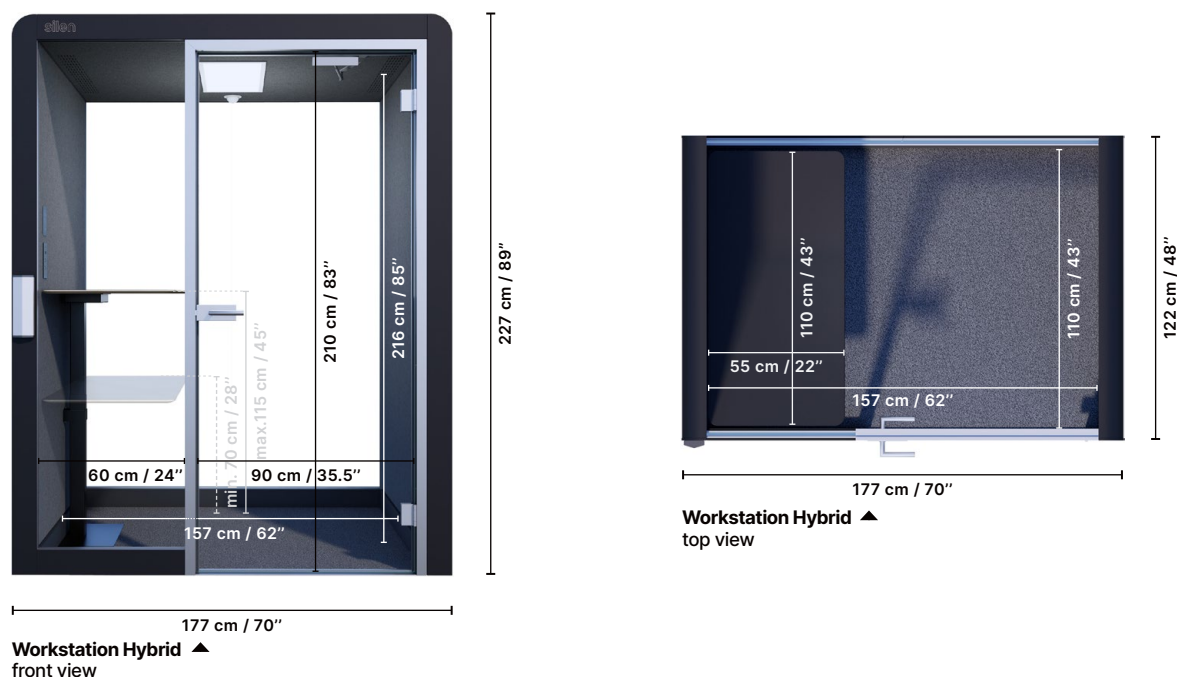

### Workstation Hybrid

Furnished with built-in height-adjustable table.

**Interior floor area**  
1.7 sqm / 18.6 sqft

## Specification

### Size

Exterior: W cm/in, H cm/in, D cm/in  
177/70 227/89 122/48

Interior: W cm/in, H cm/in, D cm/in  
157/62 216/85 110/43

### Weight

370 kg / 816 lb

### Door

Wide door; Left or Right

### Lighting

LED light; 4000K (3000K per request)  
with motion sensor; energy-efficient

### Power connection

Through the floor or ceiling;  
plug to 15 Amp power outlet

### Additional pod features

- Automatic door operator and push-to-open buttons
- Silen Dynamics Generation: easily exchangeable side skins
- Quest fabric selection for exterior walls only

### Wall, Ceiling

EchoFree acoustic panels

### Floor

Antistatic, stain resistant carpet for public spaces

### Glass

6+6 mm acoustic laminated sound control glass

### Air ventilation

Low power consumption 6.8W air circulation system ( speed - 85l/s; full air exchange time ~44s)

### Threshold

Transition 7mm

### Adjustable legs

For leveling and stability

## Finish selections

### Profiles / Door frame



### Hinges / Door handle



### Interior colours

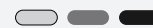

### Exterior colours

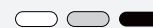

### Additional colours



### Veneer finishes



click to  
[Configure WS Hybrid](#)

**ASTM E84**  
CLASS A

acoustics  
**40 STC**

**UL** LISTED  
US UL 962

**CERTIFIED**  
**CARBON**  
**NEUTRAL**  
product

**CERTIFIED**  
ENVIRONMENTALLY  
PREFERABLE PRODUCT  
GLOBAL SOURCE

## Available Add-ons for Workstation Hybrid



### Video Call Pod

- Automatic door operator
- Wave-to-open button
- Folding chairs (set)
- Universal screen bracket
- Additional wall-integrated power socket  
2×110V + USB charging port
- Extra colour laminate

- Marshmallow exterior
- Dark Grey interior
- Grey/Aluminum profiles



### Accessible Workstation

- Automatic door operator
- Wave-to-open button
- Swivel screen bracket (on right side wall)
- Height-adjustable table (height: min 700mm, max 1150mm | table top: white; 1100×550mm)
- Lightweight pull-out stool (externally sourced)
- Additional wall-integrated power socket  
2×110V + USB charging port
- Occupancy indicator light
- Textile sides (Quest fabric selection)

- Mint cover trims
- Urchin textile sides
- Black interior
- White profiles



### Phone Booth

- Automatic door operator
- Wave-to-open button
- Folding chair
- Additional wall integrated-power socket  
2×110V + USB charging ports
- Gaia movable laptop table  
(height: 690mm/27.5")
- Airflow and lighting dimmer
- Extra colour laminate

- Eden exterior
- Light Grey interior
- Black profiles



Virtual meetings



Focused work



Phonecalls

# Get Inspired with Workstation Hybrid



<sup>1</sup> Height-adjustable tables



<sup>2</sup> Folding chairs, wall screen mounts + laptop table

scan for  
**Workstation Hybrid AR**





## Space 2 Hybrid

Accessible room for up to 4 people.

### THE PLACE TO MEET

**S2 Hybrid** is a modification of a Space 2 modular pod with all standard S2 features which also works for preferred **touch-free usage**. It features a **barrier-free** design, including the addition of a **low doorstep**, **wide door** and various **optional add-ons**.

By adding **folding chairs**, **foldable table** and **automatic door control**, **S2 Hybrid** becomes an easily **accessible pod** for a wide range of users in **office** or **public spaces**.

\* Furniture not included

## Flexible Setups



Orange exterior

### Video Call Space

Quiet video conferencing pod with a set of folding chairs and a swivel screen integrated into a side panel.



Paprika exterior

### Meeting Booth

Soundproof modular room for 2 to 4 people, ensuring uninterrupted and confidential conversations.



Cotton exterior

### Quiet Workplace

Private office featuring a height-adjustable desk and pull-out stool. Ideal workspace for one person.



Low doorstep



Modular flexibility



Sound insulation



LED



Acoustic panels



Automated air circulation



110V + 2 x USB



# Measurements

## Space 2 Hybrid

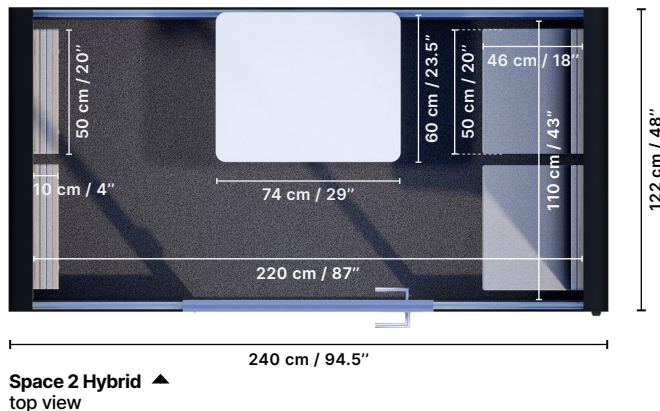
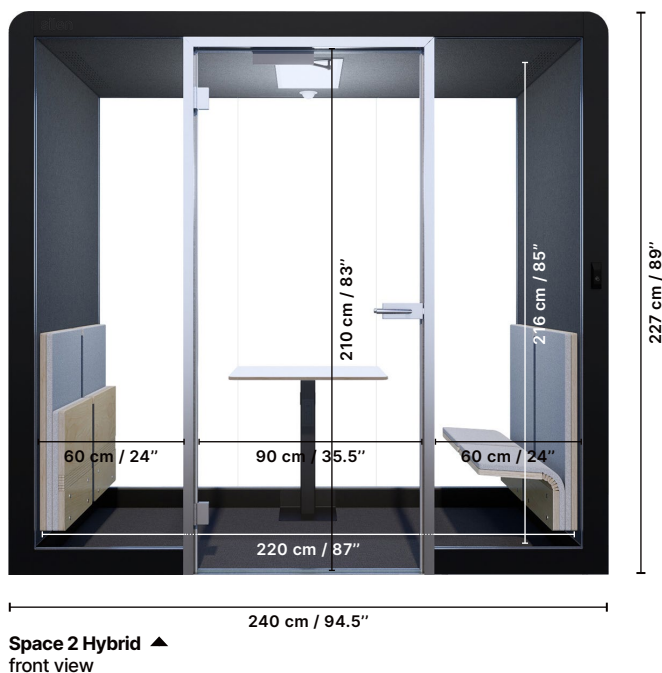

## Space 2 Hybrid Meeting Room

Furnished with 2 sets of folding chairs & integrated foldable table.

Interior floor area  
2.4 sqm / 26 sqft

## Specification

### Size

Exterior: W cm/in, H cm/in, D cm/in  
240/94 227/89 122/48

Interior: W cm/in, H cm/in, D cm/in  
220/87 216/85 110/43

### Weight

650 kg / 1433 lb

### Door

Wide door; Left or Right

### Lighting

LED light; 4000K (3000K per request)  
with motion sensor; energy-efficient

### Power connection

Through the floor or ceiling;  
plug to 15 Amp power outlet

### Additional pod features

- Automatic door operator and push-to-open buttons
- Additional Hybrid module (to create S4 Hybrid)

### Wall, Ceiling

EchoFree acoustic panels

### Floor

Antistatic, stain resistant carpet for public spaces

### Glass

6+6 mm acoustic laminated sound control glass

### Air ventilation

Low power consumption 6.8W air circulation system ( speed - 85l/s; full air exchange time ~62s)

### Threshold

Transition 7mm

### Adjustable legs

For leveling and stability

- Silen Dynamics Generation: easily exchangeable side skins

## Finish selections

### Profiles / Door frame



### Hinges / Door handle



### Interior colours



### Exterior colours



### Additional colours



### Veneer finishes



- Quest fabric selection for exterior walls only

click to  
[Configure S2 Hybrid](#)

ASTM E84  
CLASS A

acoustics  
40 STC

UL LISTED US UL 962

CERTIFIED  
CARBON  
NEUTRAL  
product

CERTIFIED  
ENVIRONMENTALLY  
PRESERVABLE PRODUCT  
GLOBAL SOURCE

## Available Add-ons for Space 2 Hybrid



### Accessible Office Booth

- **Automatic door operator**
- **Wave-to-open button**
- **Universal screen bracket**
- **Height-adjustable table** (height: min 700mm, max 1150mm | table top: white; 1100×550mm)
- **Additional wall-integrated power socket 2×110V + USB charging ports**
- **Airflow and lighting dimmer**
- **Textile sides** (Quest fabric selection)

- **Black cover trims**
- **Pebble textile sides**
- **Black interior**
- **White profiles**



### Video Conference Pod

- **Automatic door operator**
- **Wave-to-open button**
- **Folding chairs** (set)
- **Swivel screen bracket** (on right side wall)
- **Gaia movable laptop table** (height: 690mm/27.5")
- **Additional wall-integrated power socket 2×110V + USB charging port**
- **Airflow and lighting dimmer**
- **Extra colour laminate**

- **Frozen Blue exterior**
- **Dark Grey interior**
- **Black profiles**



### Flexible Meeting Room

- **Automatic door operator**
- **Wave-to-open button**
- **Folding chairs** (2 sets)
- **Integrated foldable table** (height: min 730mm | table top: white; 740×580mm)
- **Power socket 2×110V + USB charging ports** (under the table)
- **Additional wall-integrated power socket 2×110V + USB charging ports**
- **Extra colour laminate**

- **Mango exterior**
- **Light Grey interior**
- **Grey/Aluminum profiles**



Focused work



Virtual meetings



In-person meetings

# Get Inspired with Space 2 Hybrid



<sup>1</sup> Folding chairs + laptop tables



<sup>2</sup> Height-adjustable table + pull-out stool

scan for  
**Space 2 Hybrid AR**





## Space 2.5 Hybrid

Accessible room for up to 6 people.

### ONE SPACE FOR ALL

**Space 2.5 Hybrid** is **ADA compliant** and more spacious adaptation of a standard S2 **modular acoustic** booth with a **low doorstep** and enough room to carry out a convenient 360° turn in a wheelchair.

S2.5 available interior configurations include Hybrid booth - compatible furniture such as **folding chairs**, **foldable table** or **height-adjustable desk**. S2.5 Hybrid is **perfectly accessible** for all users.

\* Furniture not included

## Flexible Setups



Blue Tiber exterior

### Quiet Workspace

Private office space for one person including a lightweight pull-out stool and built-in height-adjustable desk.



Bambus exterior

### Meeting Booth

Flexible accessible acoustic pod for confidential conversations and private meetings for up to 6 people.



Basalt exterior

### Video Conference Pod

Soundproof video call room with folding chairs and a swivel screen for remote work and conversations.



Low doorstep



Modular flexibility



Sound insulation



LED



Acoustic panels



Automated air circulation



110V + 2 x USB

# Measurements

## Space 2.5 Hybrid

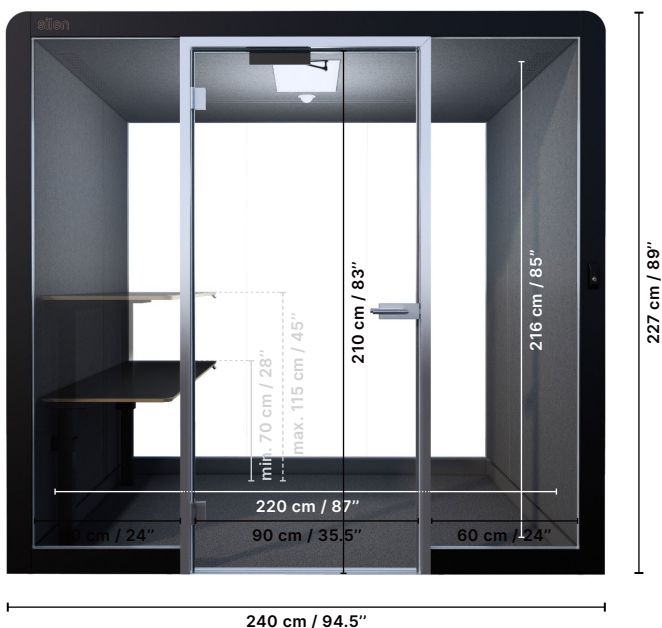

Space 2.5 Hybrid ▲  
front view

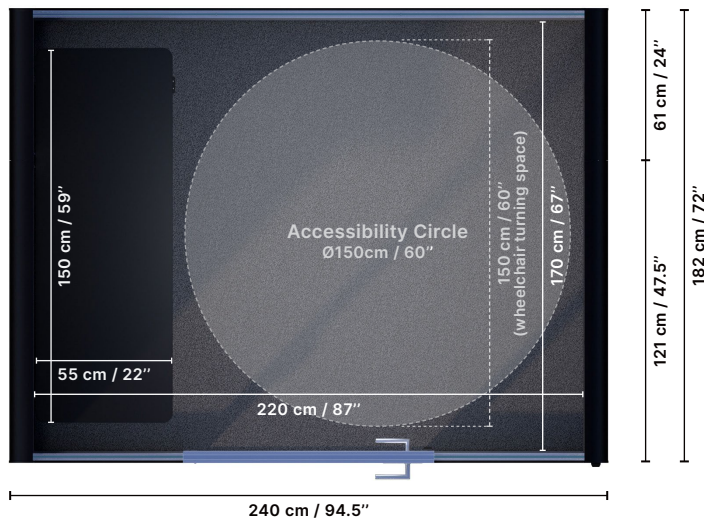

Space 2 Hybrid ▲  
top view

## Space 2.5 Hybrid Workstation

Furnished with integrated height-adjustable table.

Interior floor area  
3.7 sqm / 40.3 sqft

## Specification

### Size

Exterior: W cm/in, H cm/in, D cm/in  
240/94 227/89 182/72

Interior: W cm/in, H cm/in, D cm/in  
220/87 216/85 170/67

### Weight

787 kg / 1735 lb

### Door

Wide door; Left or Right

### Lighting

LED light; 4000K (3000K per request)  
with motion sensor; energy-efficient

### Power connection

Through the floor or ceiling;  
plug to 15 Amp power outlet

### Additional pod features

- Automatic door operator and push-to-open buttons
- Additional Hybrid module (to create S4 Hybrid)

### Wall, Ceiling

EchoFree acoustic panels

### Floor

Antistatic, stain resistant carpet for public spaces

### Glass

6+6 mm acoustic laminated sound control glass

### Air ventilation

Low power consumption 13.6W air circulation system ( speed - 110l/s; full air exchange time ~73s)

### Threshold

Transition 7mm

### Adjustable legs

For leveling and stability

- Silen Dynamics Generation: easily exchangeable side skins

## Finish selections

### Profiles / Door frame



### Hinges / Door handle



### Interior colours



### Exterior colours



### Additional colours



### Veneer finishes



- Quest fabric selection for exterior walls only

ASTM E84  
CLASS A

acoustics  
40 STC

UL LISTED  
US UL 962

CERTIFIED  
CARBON  
NEUTRAL  
product

CERTIFIED  
ENVIRONMENTALLY  
PRESERVABLE PRODUCT  
GREEN SOURCE

## Available Add-ons for Space 2.5 Hybrid



### ADA Compliant Workstation

- **Automatic door operator**
- **Wave-to-open button**
- **Height-adjustable table** (height: min 700mm, max 1150mm | table top: white; 1500×550mm)
- **Additional wall-integrated power socket 2×110V + USB charging ports**
- **Airflow and lighting dimmer**
- **Extra colour laminate**

- Mint exterior
- Light Grey interior
- Grey/Aluminum profiles



### Video Call Room

- **Automatic door operator**
- **Wave-to-open button**
- **Folding chairs**
- **Integrated foldable table** (height: min 730mm | table top: white; 740×580mm)
- **Power socket 2×110V + USB charging ports** (under the table)
- **Swivel screen bracket** (on right side wall)
- **Airflow and lighting dimmer**
- **Extra colour laminate**

- Deer exterior
- Dark Grey interior
- White profiles



### Accessible Meeting Space

- **Automatic door operator**
- **Wave-to-open button**
- **Folding chairs** (2 sets)
- **Gaia movable laptop tables** (height: 690mm/27.5")
- **Occupancy indicator light**
- **Textile sides** (Quest fabric selection)

- Oak Veneer cover trims
- Urchin textile sides
- Black interior
- Black profiles



Focused work



Virtual meetings



In-person meetings

# Get Inspired with Space 2.5 Hybrid



<sup>1</sup> Height-adjustable tables + pull-out stools



<sup>2</sup> Folding chairs + integrated foldable tables

scan for  
**Space 2.5 Hybrid AR**



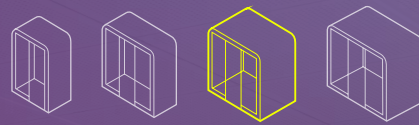

## Space 4 Hybrid

Meeting room for 4 - 8 people.

### EVERYONE CAN JOIN

**Space 4 Hybrid** allows others to join in on the conversation and have a bigger meeting. It fits up to **four wheelchair users**, otherwise **up to eight** side-by-side.

This **acoustic office booth** with all original Silen features and the addition of sleek, room-saving **folding chairs**, **foldable table**, **low doorstep**, and **touch-free access** gives everyone accessibility and the option to use this **modular pod** for **meetings**, **work** or project **presentations**.

\* Furniture not included

## Flexible Setups



■ Bambus exterior

### Meeting Room

Acoustic space for up to 8 people, ensuring your meeting and work sessions stay uninterrupted.



■ Jade exterior

### Quiet Workplace

Flexible and accessible private office furnished with a height - adjustable desk, folding chairs, and a TV screen.



■ Silver Grey exterior

### Video Conference Booth

Soundproof video conferencing pod with a foldable table, set of folding chairs, sofa, and swivel screen.



Low doorstep



Modular flexibility



Sound insulation



LED



Acoustic panels



Automated air circulation



110V + 2 x USB



# Measurements

## Space 4 Hybrid

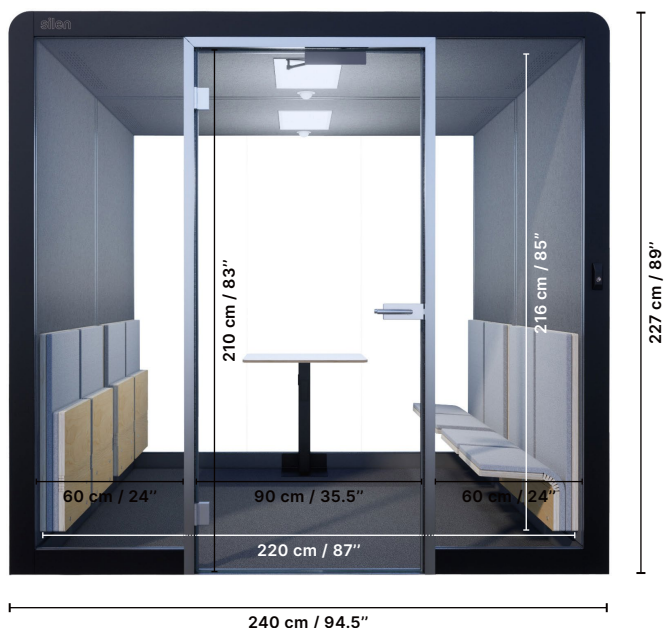

Space 4 Hybrid ▲  
front view

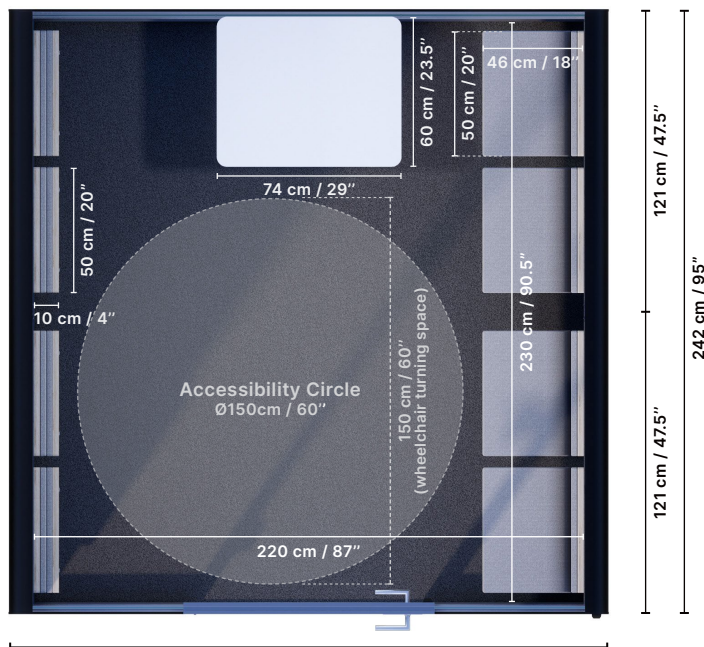

Space 4 Hybrid ▲  
top view

### Space 4 Hybrid Meeting Room

Furnished with 4 sets of folding chairs & integrated foldable table.

Interior floor area  
5.1 sqm / 54.5 sqft

## Specification

### Size

Exterior: W cm/in, H cm/in, D cm/in  
240/94 227/89 242/95

Interior: W cm/in, H cm/in, D cm/in  
220/87 216/85 230/90

### Weight

1140 kg / 2513 lb

### Door

Wide door; Left or Right

### Lighting

LED light; 4000K (3000K per request)  
with motion sensor; energy-efficient

### Power connection

Through the floor or ceiling;  
plug to 15 Amp power outlet

### Additional pod features

- Automatic door operator and push-to-open buttons
- Silen Dynamics Generation: easily exchangeable side skins
- Quest fabric selection for exterior walls only

### Wall, Ceiling

EchoFree acoustic panels

### Floor

Antistatic, stain resistant carpet for public spaces

### Glass

6+6 mm acoustic laminated sound control glass

### Air ventilation

Low power consumption 13.6W air circulation system (speed - 125l/s; full air exchange time ~87s)

### Threshold

Transition 7mm

### Adjustable legs

For leveling and stability

## Finish selections

### Profiles / Door frame



### Hinges / Door handle



### Interior colours



### Exterior colours



### Additional colours



### Veneer finishes



click to  
[Configure S4 Hybrid](#)

ASTM E84  
CLASS A

acoustics  
40 STC

C  US UL 962  
LISTED

CERTIFIED  
CARBON  
NEUTRAL®  
product

CERTIFIED  
ENVIRONMENTALLY  
PRESERVABLE PRODUCT  
GREEN SOURCE

## Available Add-ons for Space 4 Hybrid



### Private Office

- **Automatic door operator**
- **Wave-to-open button**
- **Folding chairs** (set)
- **Swivel screen bracket** (on right side wall)
- **Height-adjustable table** (height: min 700mm, max 1150mm | table top: black; 1100×550mm)
- **Vega low-back modular sofa**
- **Additional wall-integrated power socket 2×110V + USB charging port**
- **Airflow and lighting dimmer**
- **Textile sides** (Quest fabric selection)

- Azurite cover trims
- Limpet textile sides
- Dark Grey interior
- Black profiles



### Accessible Meeting Room

- **Automatic door operator**
- **Wave-to-open button**
- **Folding chairs** (2 sets)
- **Integrated foldable table** (height: 730mm | table top: white; 740×580mm)
- **Power socket 2×110V + USB charging ports** (under the table)
- **Vega low-back modular sofa** (set)
- **Extra colour laminate**

- Storm Grey exterior
- Light Grey interior
- White profiles



### ADA Compliant Video Call Pod

- **Automatic door operator**
- **Wave-to-open button**
- **Folding chairs** (2 sets)
- **Integrated foldable table** (height: 730mm | table top: white; 740×580mm)
- **Power socket 2×110V + USB charging ports** (under the table)
- **Swivel screen bracket**
- **Occupancy indicator light**
- **Extra colour laminate**

- Opal exterior
- Black interior
- Grey/Aluminum profiles



Focused work



In-person meetings



Virtual meetings

# Get Inspired with Space 4 Hybrid



<sup>1</sup> Folding chairs + built-in foldable table



<sup>2</sup> Height-adjustable table, pull-out stool + folding chairs

scan for  
**Space 4 Hybrid AR**





\* Equipment by Synctuition included

# MINDSPA<sup>®</sup>

BY SYNCTUITION

## STEP INTO THE MINDSPA

World's First Premium Relaxation Booth.

Prepare your mind for **sweet dreams**.  
Wash away your daily **problems** and **worries**.  
Keep your mind **healthy** and **young**.

**MindSpa** is a Space 2 acoustic pod **upgrade** that has been designed in collaboration with Synctuition, who are experts in the **mindfulness** field. This quiet, cozy and comfortable **meditation space** allows you to achieve **clarity of mind** in a matter of

## Relaxation Booth



### Complete Privacy

Relax in total silence and perfect solitude.

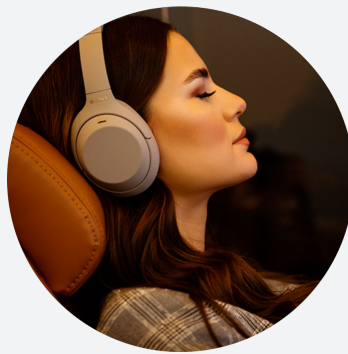

### Premium Equipment

Modern technology for advanced relaxation techniques.

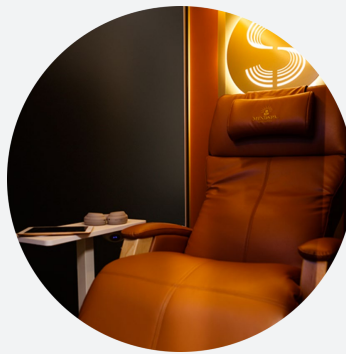

### Versatile

Can be used for meditation, mindfulness, or work.



### Unique Atmosphere

Mood lighting for enhancing the experience of relaxation.



Wheels included



Sound insulation



LED



Acoustic panels



Automated air circulation



110V + USB-A + Wireless charger

# Measurements

## MindSpa

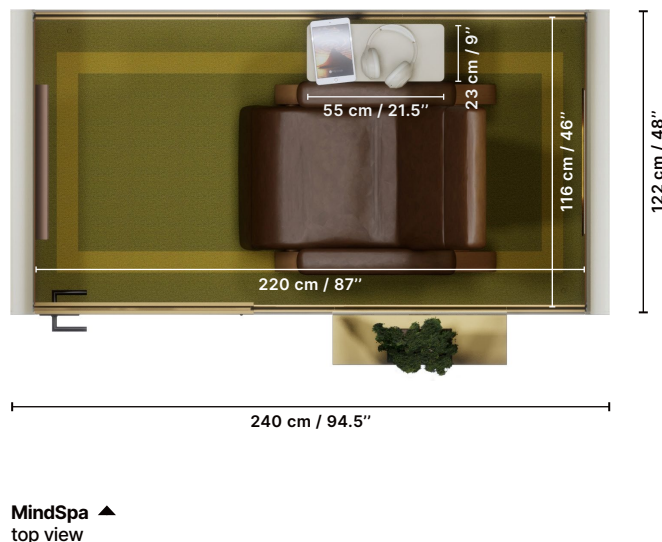

### MindSpa Relaxation Room

Furnished with adjustable chair; includes Synctuition equipment.

Interior floor area  
2.6 sqm / 27.5 sqft

## Specification

### Size

Exterior: W cm/in, H cm/in, D cm/in  
240/94 229/90 122/48

Interior: W cm/in, H cm/in, D cm/in  
220/87 205/81 116/46

### Weight

670 kg / 1477 lb

### Door

Left or Right

### Lighting

LED light; 4000K (3000K per request)  
with motion sensor; energy-efficient

### Power connection

Through the floor or ceiling;  
plug to 15 Amp power outlet

### Additional pod features

- Automatic door operator and push-to-open buttons
- Silen Dynamics Generation: easily exchangeable side skins
- Quest fabric selection for exterior walls only

### Wall, Ceiling

EchoFree acoustic panels

### Floor

Antistatic, stain resistant carpet for public spaces

### Glass

6+6 mm tinted acoustic laminated sound control glass

### Air ventilation

Low power consumption 6.8W air circulation system ( speed - 85l/s; full air exchange time ~62s)

### Casters

For easy relocation

### Adjustable legs

For leveling and stability

## Finish selections

### Profiles / Door frame

Standard: Optional:

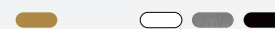

### Hinges / Door handle

Standard: Optional:

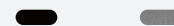

### Exterior colours



### Additional colours and finishes



### Veneer finishes



click to  
[Configure MindSpa](#)

ASTM E84  
CLASS A

acoustics  
43 STC

UL LISTED US UL 962

CERTIFIED  
CARBON  
NEUTRAL<sup>®</sup>  
product

CERTIFIED  
ENVIRONMENTALLY  
PREFERABLE PRODUCT<sup>™</sup>  
GLOBAL SOURCE

## Flexible Usage

### MindSpa

 Noisy offices

 Airports

 Universities

 Public spaces

 Hotel lobbies

 Spas & relaxation

 Health care

 Sports teams

## Optimized Mind · Mental Health · Well - Being

**MindSpa** is an **acoustic** and **private space** for **relaxation** and **meditation** based on **modern design**, **meditation techniques** and **premium equipment**. With a unique combination of three-dimensional **nature sounds**, **binaural beats** and **relaxation techniques**, you will feel **recharged and rejuvenated in only 25 minutes**. The benefits of a relaxed mind cannot be overstated. MindSpa will **optimize your mind** to **increase creativity**, **productivity** and **improve your motivation**.

Relaxation is the process that **decreases** the harmful effects of **stress** on the mind and body and it is very **important for your mental health**. That's why **MindSpa** could be extremely **beneficial in any space** where it's necessary to **remove** any **stressors**, to **improve** general **mood** or **develop better thoughts, relationships**, and a **more positive environment** for culture building.

## Premium Features

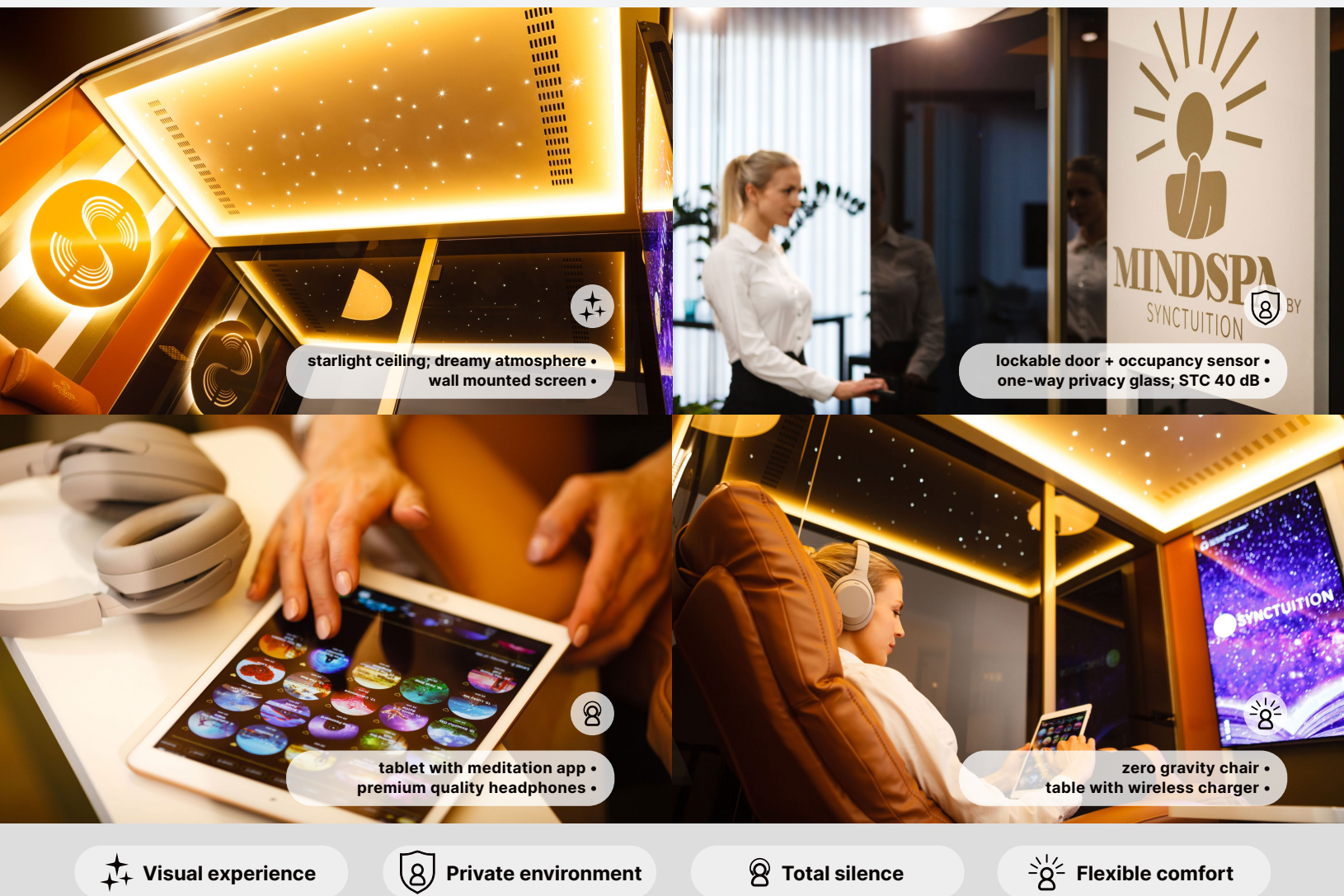



starlight ceiling; dreamy atmosphere •  
wall mounted screen •

lockable door + occupancy sensor •  
one-way privacy glass; STC 40 dB •

tablet with meditation app •  
premium quality headphones •

zero gravity chair •  
table with wireless charger •

 Visual experience

 Private environment

 Total silence

 Flexible comfort

# Get Inspired with MindSpa



scan for  
MindSpa AR



## Finish Selections

### Interior Colours

#### Standard wall and ceiling.

EchoFree acoustic paneling



Light Grey  
1893



Dark Grey  
1897



Black  
1961

#### Standard floor.

Desso Essence carpet

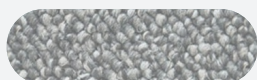

Light Grey  
9507



Dark Grey  
9502

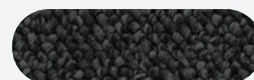

Black  
9990

### Aluminum Profiles

#### Doors, glass profiles and inside connections.



White  
RAL 9003 profiles  
White anodized door fittings



Anodized Grey  
Grey anodized profiles



Black  
RAL 9005 profiles  
Black door fittings

### Door Hardware

#### Handle and hinges.



Anodized Grey  
Grey anodized door fittings



Black  
RAL 9005 profiles  
Black door fittings

### Exterior Colours

#### Standard exterior finishes.

Front and back trims: HPL from Egger and Resopal; Exterior sides: powder-coated metal changeable skins



Snow White  
RAL 9013



Silver Grey  
RAL 7035



Black  
RAL 9011

### Modular Sofa Colours

#### Standard fabric colours.

QUEST - Eco-friendly fabric from Camira.



Light Grey  
QUE 02

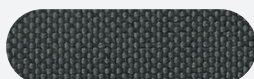

Dark Grey  
QUE 04

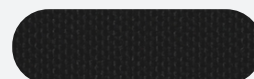

Black  
QUE 01



## Additional Finishes



### Exterior Colours

#### Additional exterior finishes.

Front and back trims: laminate from Innovus; Exterior sides: powder-coated metal changeable skins

	<b>Cotton</b> RAL 7044		<b>Myosotis</b> RAL 4009
	<b>Basalt</b> RAL 7048		<b>Orange</b> RAL 2008
	<b>Coal</b> RAL 7022		<b>Paprika</b> RAL 2013
	<b>Bambus</b> RAL 120 60 10		<b>Mango</b> RAL 080 80 60
	<b>Mint</b> RAL 6019		<b>Deer</b> RAL 1024
	<b>Jade</b> RAL 6034		<b>Hot Pepper</b> RAL 3020
	<b>Opal</b> RAL 220 40 15		<b>Azurite</b> RAL 5008
	<b>Eden</b> RAL 6005		<b>Blue Tiber</b> RAL 5003
	<b>Citrus Green</b> RAL 100 80 60		<b>Storm Gray</b> RAL 240 50 05
	<b>Marshmallow</b> RAL 040 80 10		<b>Frozen Blue</b> RAL 250 70 10

#### Veneer finishes.

	<b>Oak Veneer</b> R0015 - Planked
	<b>Dark Oak Veneer</b> TH009 - Planked

## Additional Finishes

### Textile Colours (Modular Sofas & Pod Textile Sides)

#### Additional fabric colours.

QUEST - Eco-friendly fabric from Camira.

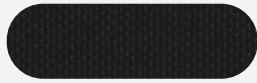

Depth  
QUE 01

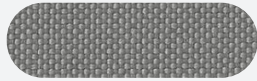

Fossil  
QUE 02



Bernacle  
QUE 03



Mussel  
QUE 04

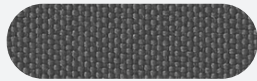

Quartz  
QUE 05

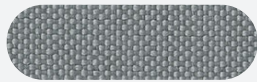

Shell  
QUE 06



Ripple  
QUE 07

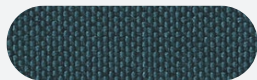

Whelk  
QUE 08

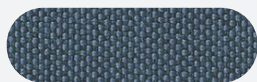

Limpet  
QUE 09

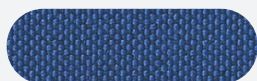

Rock Pool  
QUE 10



Wave  
QUE 11



Tide  
QUE 12

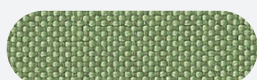

Sea Grass  
QUE 13

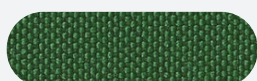

Algae  
QUE 14



Kelp  
QUE 15



Sea Foam  
QUE 16



Urchin  
QUE 17



Abalone  
QUE 18



Driftwood  
QUE 19



Sandstone  
QUE 20

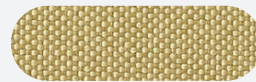

Beach Comber  
QUE 21



Salt  
QUE 22

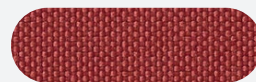

Cockle  
QUE 23

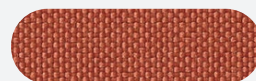

Crab  
QUE 24

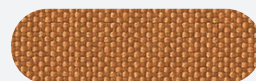

Clay  
QUE 25

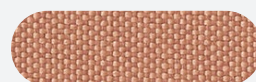

Shrimp  
QUE 26

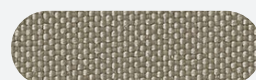

Pebble  
QUE 27

# Best Features & High-End Materials

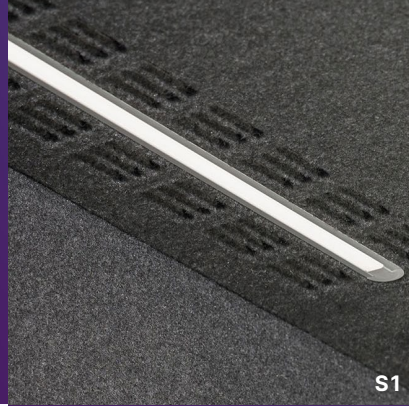

S1

◀ **Lights**  
Energy-efficient LED lights controlled by the presence detectors.



S1

◀ **Exterior**  
Laminated wood exterior trims and changeable metal powder-coated exterior sides.

**Aluminum Profiles & Gasket** ▶  
For doors, glass wall and inside connections.



◀ **Glass**  
6+6 mm laminated soundcontrol clear glass.

**Hinges**  
Door profile-to-glass hinge that seals the door perfectly.

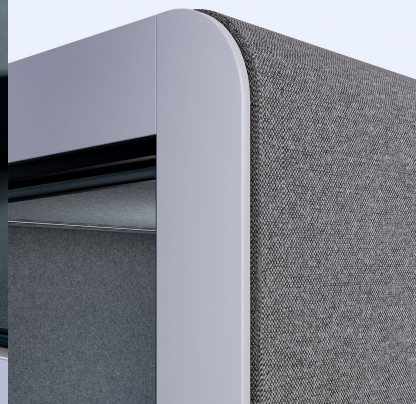
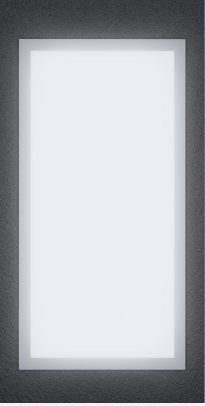

▲ **Laptop Table**  
Standard 1050mm / 41" metal built-in table with whiteboard.



S1

▶ **Air Ventilation**  
Automated air circulation.

▲ **Textile Sides (optional)**  
Quest fabric selection for Silen Dynamics exterior walls only.



◀ **Door**  
Right or left-handed orientation.



S1

◀ **Integrated Power Outlet**  
110 V + USB + USB-C.

**Built-in floor power outlet** ▶  
2 × 110 V + 2 × USB.



# Features

Chatbox Product Line

**Modular.  
Acoustic.  
Effortless.**

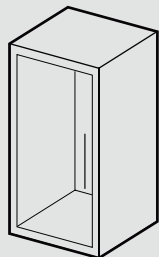

**Single.**

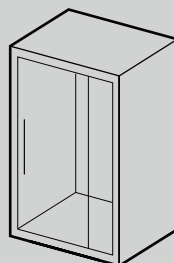

**Solo.**

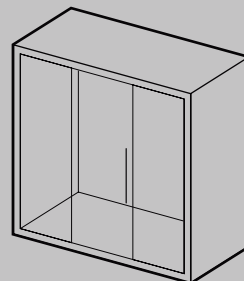

**Duo.**

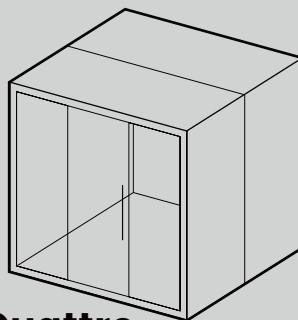

**Quattro.**

# Features

## Air Ventilation

Automated **air circulation**.

## Lighting

The energy-efficient **LED lights**.

## Motion Sensor

The presence detectors.

## Wall, Ceiling

EchoFree **acoustic** panels.

## Exterior

**Magnetic** exterior sides. **Easily changeable** painted metal sheets;

Available in standard **black / white** powder-coated finish, **8 colour collection side** shades and another 2 unique finishes.

## Airflow & Lighting Dimmer

(optional)

## Power Connections

Electrical **floor or wall sockets** with integrated charging ports.

## Glass

**Soundcontrol** laminated safety clear **glass** up to 35 STC.

## Door

Changeable door swing; (left or right upon assembly).

## Furniture

Stools, modular benches and side tables - optional (not included).

## Interior

**Fire resistant**, hypoallergenic, antibacterial and scent-free walls and floor materials.

## Floor

Antistatic, stain resistant carpet.

## Electrical Connection

Power cord fed through the ceiling or floor to 120V power outlet.

## Adjustable Legs

For **levelling** and stability.





## Thoughtfully designed.

### Acoustic

**Chatbox** is designed for focused **work**, creative **meetings**, making **phone calls**, **video chats**, and silence in any space. It ensures all conversations stay private while keeping background noise out.

### Durable

Well **thought - out form**, choice of **materials** and booth **construction** allow for extended **durability**. In addition, **easy assembly** and disassembly allow you to take it to your next office space.

### Affordable

Utilizing **durable** yet **cost-effective** materials, Chatbox pod is **shipped** through regular mail service **flat packed** directly from our factory to you, making it a convenient and **accessible choice**.



visit us  
online

## Ventilated

This new **multifunctional** teammate uses the **same technology** as Silen Space pods that keeps all the Chatbox booths **ventilated**, ensuring **fresh air** throughout your time spent inside.

## Quickly assembled

It takes about 60 minutes for **two people to assemble** Single pod - and you only need one tool. It is so **effortless**, easy and your space ends up being more **useful** than any other solution.

## Silen inspired

Chatbox is designed, tested, and **produced by** the team behind **Silen Space** modular office pods. Chatbox brings their simplified version with its essential purpose in the **balanced functional form**.

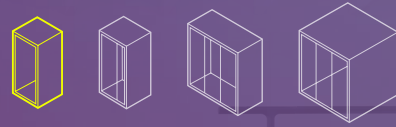

## Single

Silent room for 1 person.

### STYLISH ISLAND OF PRIVACY

Chatbox represents a simplified and more affordable form of a standard Silen **acoustic room** that improves any work environment.

**Single** is a **one-person capacity** space to **focus** on your **work** or make private **phone calls** that will not be interrupted by outside distractions anymore. This compact member of our acoustic pods family in a **sleek, high-quality design** is here to **support your ideas** in reaching their full potential.

\* Table included only

## Flexible Setups



— Cotton exterior

### Quiet Workstation

Ideal for solo work, this acoustic pod features integrated whiteboard table and a 360° revolving stool.



— Black exterior

### Standard Booth

One-person capacity space with a standard-height built-in table, and (optional) built-in swivel stool.



— Opal exterior

### Video Call Room

Private video call room with a standard built-in table, height-adjustable stool and full V/C readiness.



Sound insulation



LED



Acoustic panels



Automated air circulation



110V + USB + USB-C



Built-in table



# Measurements

## Single

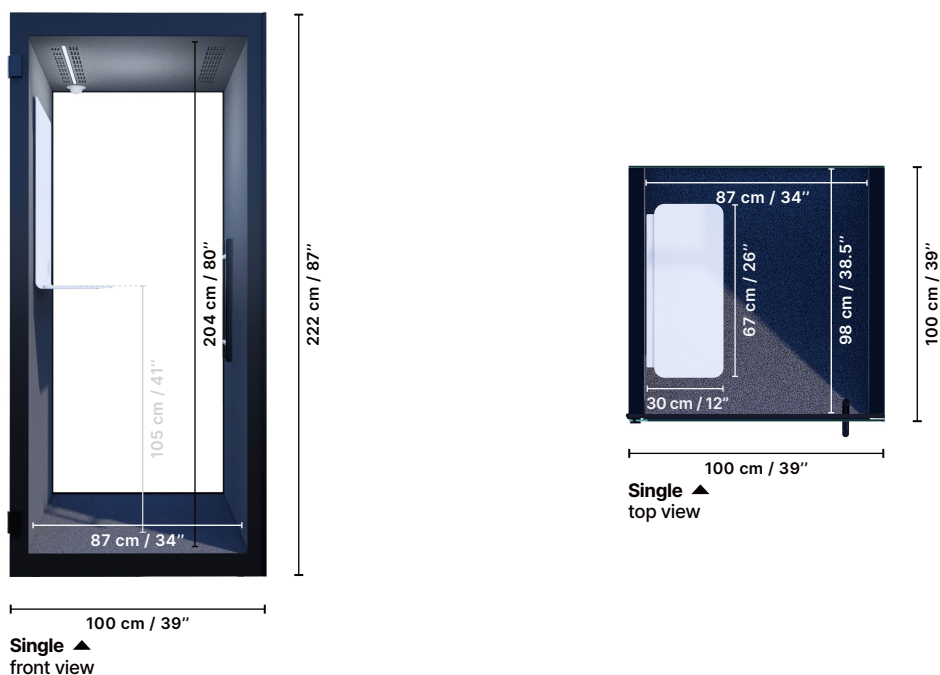

### Single Phone Booth

Furnished with built-in table with integrated power outlets.

Interior floor area  
0.9 sqm / 9.2 sqft

## Specification

<p><b>Size</b> Exterior: W cm/in, H cm/in, D cm/in 100/39 222/87 100/39</p> <p>Interior: W cm/in, H cm/in, D cm/in 87/34 204/80 98/38</p> <p><b>Weight</b> 330 kg / 727.5 lb</p> <p><b>Door</b> Left- and Right- handed door in one</p> <p><b>Lighting</b> LED light; 4000K (3000K per request) with motion sensor; energy-efficient</p> <p><b>Power connection</b> Through the floor or ceiling; plug to 15 Amp power outlet</p>	<p><b>Wall, Ceiling</b> EchoFree acoustic panels</p> <p><b>Floor</b> Antistatic, stain resistant carpet for public spaces</p> <p><b>Glass</b> 4+4 mm acoustic laminated sound control glass</p> <p><b>Exterior</b> Painted sheet metal</p> <p><b>Air ventilation</b> Low power consumption 3.4W air circulation system ( speed - 22l/s; full air exchange time ~79s)</p> <p><b>Adjustable legs</b> For leveling and stability</p>	<p><b>Finish selections</b></p> <p><b>Profiles / Door frame</b> <input type="checkbox"/></p> <p><b>Hinges / Door handle</b> <input type="checkbox"/></p> <p><b>Interior colours</b> <input type="checkbox"/></p> <p><b>Exterior colours ( exterior sides )</b> <input type="checkbox"/> <input type="checkbox"/></p> <p><b>Additional colours</b> <input type="checkbox"/> <input type="checkbox"/> <input type="checkbox"/> <input type="checkbox"/> <input type="checkbox"/> <input type="checkbox"/> <input type="checkbox"/> <input type="checkbox"/></p> <p><b>Unique finishes</b> <input type="checkbox"/> <input type="checkbox"/></p>
---	---	---

click to  
**Configure Single**

**ASTM E84**  
CLASS A

acoustics  
**35 STC**

**UL** LISTED  
US UL 962

**CERTIFIED**  
**CARBON**  
**NEUTRAL**  
product

**CERTIFIED**  
**ENVIRONMENTALLY**  
**PREFERABLE PRODUCT**  
GLOBAL SOURCE

## Available Add-ons for Single



### Phone Booth

- Centered **built-in table** (height: 1050mm/41") with magnetic whiteboard (700 × 750mm)
- **360° revolving stool** (bar-height: 760mm/30")
- **Power socket 110V + USB charging ports**
- **Air flow and lighting dimmer**
- **Colour collection sides**

- **Marshmallow** exterior
- **Dark Grey** interior
- **Black** profiles



### Video Conference Pod

- **Screen bracket + full V/C readiness**
- Additional **power outlet** for screen
- Centered **built-in table** (height: 1050mm/41")
- **Power socket 110V + USB charging ports**
- **Integrated adjustable swivel stool** (height: min 560mm, max 820mm | seat: ø350mm)

- **Slatted Oak** exterior
- **Dark Grey** interior
- **Black** profiles



### Private Workstation

- Centered **built-in table** (height: 1050mm/41")
- **Power socket 110V + USB charging ports**
- **Height-adjustable task chair** (externally sourced)
- **Colour collection sides**

- **Azurite** exterior
- **Dark Grey** interior
- **Black** profiles



Phonecalls



Virtual meetings



Short work

# Get Inspired with Single



<sup>1</sup> V/C readiness, built-in tables + height-adjustable stools



<sup>2</sup> Built-in tables + revolving stools

scan for  
**Single AR**





## Solo

Workstation for 1 person.

### ERGONOMIC WORKSTATION

**Solo** is an ergonomic private workspace for **one person**. This unique office booth has **excellent acoustic features** and more spacious interior for **focused work** sessions and **uninterrupted phone calls**. It comes with a fixed or height-adjustable table which can be combined with a low-back modular sofa or a task chair.

Spice up the office vibe within no time by adding **Solo phone booth, workstation** or **video call pod** to any open space office.

\* Table included only

## Flexible Setups

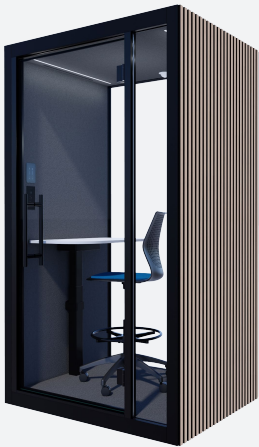

Slatted Oak exterior

### Quiet Workspace

One-person capacity workstation that includes a height-adjustable table and (optional) task chair.



White exterior

### Lounge Phone Booth

Private space with a modular sofa for long phone conversations that stay confidential.



Storm Grey exterior

### Video Conference Pod

V/C ready office booth for one user featuring a fixed-height table and swivel chair.



Sound insulation



LED



Acoustic panels



Automated air circulation



110V + USB + USB-C



Built-in table

# Measurements

## Solo

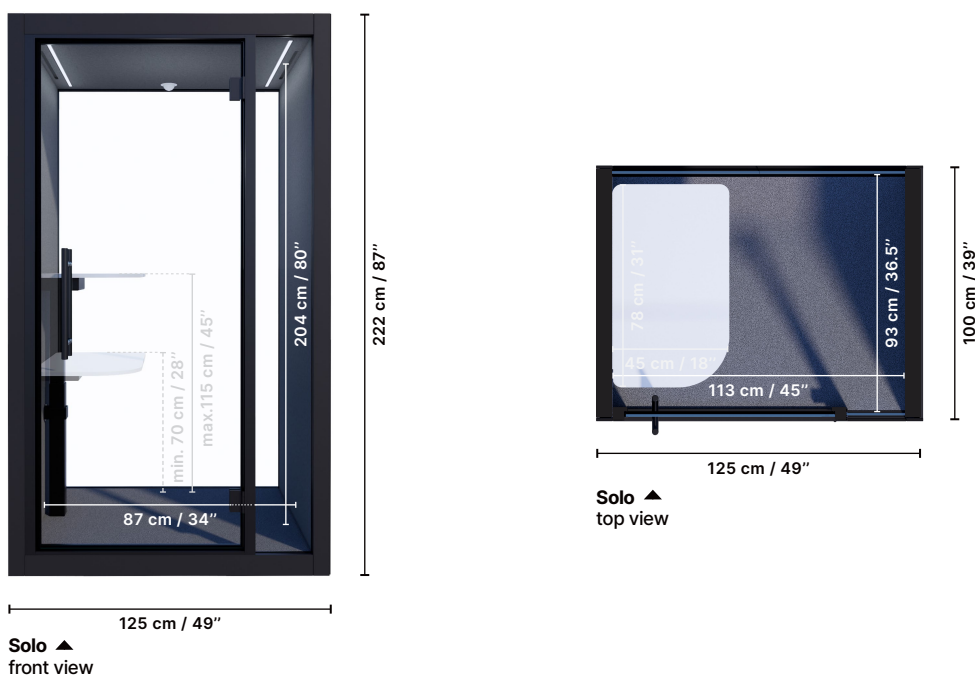

### Solo Workstation

Furnished with height-adjustable table.

Interior floor area  
1.1 sqm / 11.3 sqft

## Specification

### Size

Exterior: W cm/in, H cm/in, D cm/in  
125/49 222/87 100/39

Interior: W cm/in, H cm/in, D cm/in  
113/45 204/80 93/37

### Weight

380 kg / 838 lb

### Door

Left- and Right- handed door in one

### Lighting

LED light; 4000K (3000K per request)  
with motion sensor; energy-efficient

### Power connection

Through the floor or ceiling;  
plug to 15 Amp power outlet

### Wall, Ceiling

EchoFree acoustic panels

### Floor

Antistatic, stain resistant carpet for  
public spaces

### Glass

6+6 mm acoustic laminated sound  
control glass

### Exterior

Painted sheet metal

### Air ventilation

Low power consumption 5.1W air  
circulation system ( speed - 55l/s;  
full air exchange time ~39s)

### Adjustable legs

For leveling and stability

## Finish selections

### Profiles / Door frame



### Hinges / Door handle



### Interior colours



### Exterior colours ( exterior sides )



### Additional colours



### Unique finishes



ASTM E84  
CLASS A

acoustics  
35 STC

UL LISTED US UL 962

CERTIFIED  
CARBON  
NEUTRAL  
product

CERTIFIED  
ENVIRONMENTALLY  
PREFERABLE PRODUCT  
GLOBAL SOURCE

## Available Add-ons for Solo



### Lounge Phone Booth

- Fixed-height table (height: 700mm/28" | table top: white; 780×450mm)
- Power socket 110V + USB charging ports
- Vega low-back task sofa
- Air flow and lighting dimmer
- Colour collection sides

- Paprika exterior
- Dark Grey interior
- Black profiles



### Quiet Workstation

- Height-adjustable table (height: min 700mm, max 1150mm | table top: white; 780×450mm)
- Additional wall-integrated power socket 2×110V + USB charging ports
- Height-adjustable chair (externally sourced)
- Colour collection sides

- Azurite exterior
- Dark Grey interior
- Black profiles



### Video Conference Booth

- Screen bracket + full V/C readiness
- Additional power outlet for screen
- Fixed-height table (height: 700mm/28" | table top: white; 780×450mm)
- Vega low-back task sofa
- Power socket 110V + USB charging ports
- Air flow and lighting dimmer

- Black exterior
- Dark Grey interior
- Black profiles



Phonecalls



Short work



Virtual meetings

**Get Inspired  
with Solo**



<sup>1</sup> Fixed-height tables + Vega low-back task sofas



<sup>2</sup> Height-adjustable tables + task chairs



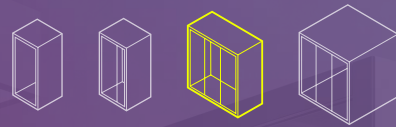

## Duo

Silent room for 2 people.

### A CONVERSATIONAL NECESSITY

**Duo** is a private **meeting room** which helps you to **connect, collaborate** and **focus**.

This acoustic room is perfect for **1:1 meetings** and small **brainstorm sessions**. It fits **two to four people** and allows you to quickly get on the same page again. In addition to all the comforts of the booth, you can also add custom sofas, tables, screen, or desk to achieve **flexibility** and **space - efficiency**.

\* Furniture not included

## Flexible Setups



Black exterior

### Meeting Space

Private meeting room configuration with movable laptop tables, wall-integrated screen bracket, and modular sofa set.



White exterior

### Standard Booth

2-person capacity acoustic space with low-back sofas and integrated table for work or confidential conversations.



Marshmallow exterior

### Private Office

Compact acoustic pod including height-adjustable desk and swivel chair, that serves as an efficient workstation.



Modular flexibility



Sound insulation



LED



Acoustic panels



Automated air circulation



110V + 2 x USB



# Measurements

## Duo

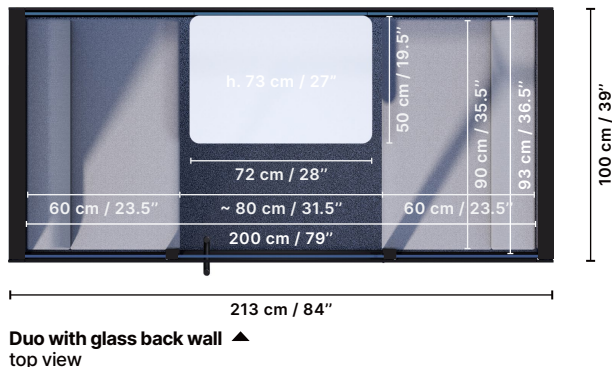
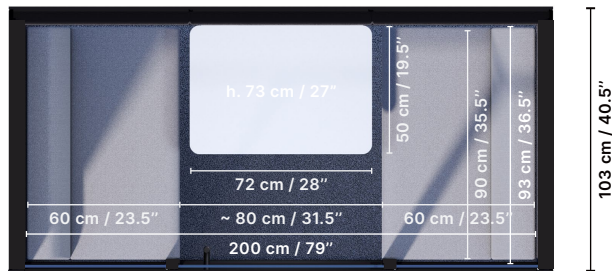
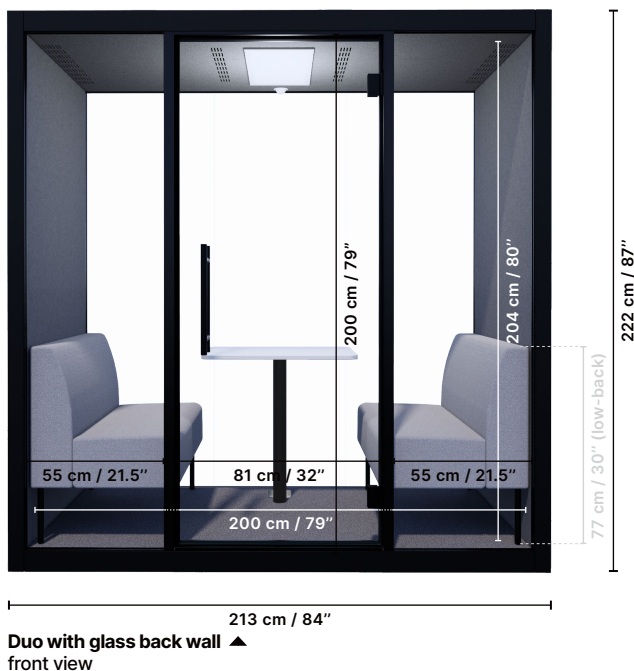

### Duo Meeting Room

Furnished with set of Vega low-back sofas & integrated table.

**Interior floor area**  
1.9 sqm / 20 sqft

# Specification

### Size

Exterior: W cm/in, H cm/in, D cm/in  
213/84 222/87 100/39  
\*with solid back wall: 103/41

Interior: W cm/in, H cm/in, D cm/in  
200/79 204/80 93/37

### Weight

490 kg / 1080 lb \*(550kg / 1212 lb)

### Door

Left- and Right- handed door in one

### Lighting

LED light; 4000K (3000K per request) with motion sensor; energy-efficient

### Power connection

Through the floor or ceiling; plug to 15 Amp power outlet

### Wall, Ceiling

EchoFree acoustic panels

### Floor

Antistatic, stain resistant carpet for public spaces

### Glass

6+6 mm acoustic laminated sound control glass

### Exterior

Painted sheet metal

### Air ventilation

Low power consumption 5.1W air circulation system ( speed - 55l/s; full air exchange time ~69s)

### Adjustable legs

For leveling and stability

# Finish selections

### Profiles / Door frame



### Hinges / Door handle



### Interior colours



### Exterior colours ( exterior sides )

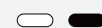

### Additional colours

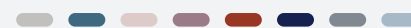

### Unique finishes



click to **Configure Duo**



## Available Add-ons for Duo



### Video Call Lounge

- **Integrated table** (height: 730mm/29" | table top: white; 500×716mm)
- **Screen bracket on back glass** (+VESA mount)
- **Vega low-back modular sofa** (set)

- **Slatted Oak** exterior
- **Dark Grey** interior
- **Black** profiles



### Meeting Room

- **Vega low-back modular sofa** (set)
- **Gaia movable laptop tables** (height: 690mm/27.5")
- **Wall power socket 2×110V + USB charging ports**
- **Magnetic whiteboard** (900×600mm)

- **Black** exterior
- **Dark Grey** interior
- **Black** profiles



### Quiet Workplace

- **Height-adjustable table** (height: min 700mm, max 1150mm | table top: white; 900×550mm)
- **Additional wall-integrated power socket 2×110V + USB charging ports**
- **Height-adjustable chair** (externally sourced)
- **Airflow and lighting dimmer**
- **Colour collection sides**

- **Opal** exterior
- **Dark Grey** interior
- **Black** profiles



Virtual meetings



In-person meetings



Focused work

# Get Inspired with Duo



<sup>1</sup> Vega low-back modular sofa sets, integrated tables + screen mount



<sup>2</sup> Height-adjustable tables +office chairs

scan for  
Duo AR



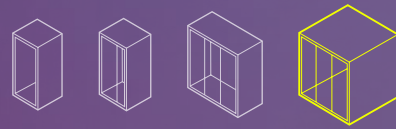

## Quattro

Silent room for up to 6 people.

### SUPPORTS YOUR IDEAS

**Boost your productivity** in any office that is a bit too open. Each space deserves a **Quattro** - a **private room** for deep **work**, **confidential calls**, or **creative sessions**.

**Quattro** acoustic booth is designed for **four to six people**, making it the ideal place to **co-create**, **brainstorm**, **focus**, **work** and **discuss** with your **team members** or **business clients** in complete privacy.

\* Furniture not included

## Flexible Setups



— Frozen Blue exterior

### Presentation Space

Versatile private space with a built-in table, glass screen bracket, and modular sofa set for up to 6 people.



— Black exterior

### Meeting Lounge

Acoustic meeting space for work, private gatherings, and confidential conversations for 4 - 5 people.



— Slatted Oak exterior

### Acoustic Workstation

Quiet one-person workstation with height-adjustable table, integrated screen bracket and lounge seating.



Modular flexibility



Sound insulation



LED



Acoustic panels



Automated air circulation



110V + 2 x USB

# Measurements

## Quattro



Quattro ▲  
front view

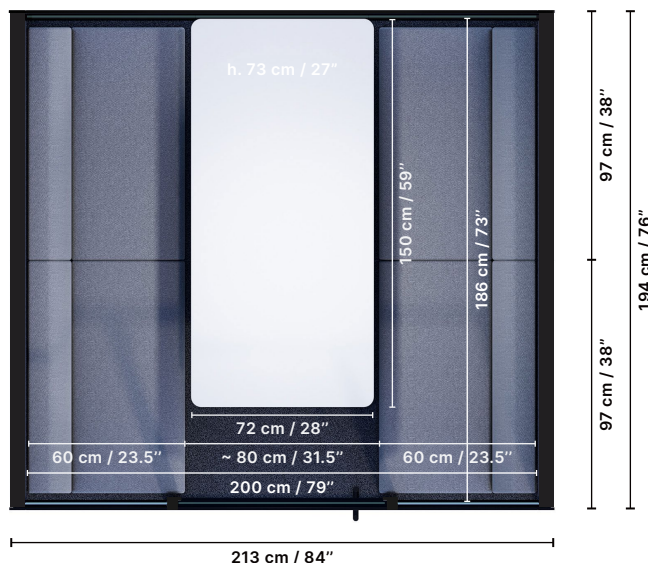

Quattro ▲  
top view

### Quattro Meeting Room

Furnished with 2 sets of Vega low-back sofas & integrated table.

Interior floor area  
3.7 sqm / 40 sqft

## Specification

### Size

Exterior: W cm/in, H cm/in, D cm/in  
213/84 222/87 194/76

Interior: W cm/in, H cm/in, D cm/in  
200/79 204/80 186/73

### Weight

980 kg / 2160 lb

### Door

Left- and Right- handed door in one

### Lighting

LED light; 4000K (3000K per request)  
with motion sensor; energy-efficient

### Power connection

Through the floor or ceiling;  
plug to 15 Amp power outlet

### Wall, Ceiling

EchoFree acoustic panels

### Floor

Antistatic, stain resistant carpet for  
public spaces

### Glass

6+6 mm acoustic laminated sound  
control glass

### Exterior

Painted sheet metal

### Air ventilation

Low power consumption 10.2W air  
circulation system ( speed - 85l/s;  
full air exchange time ~89s)

### Adjustable legs

For leveling and stability

## Finish selections

### Profiles / Door frame



### Hinges / Door handle



### Interior colours



### Exterior colours ( exterior sides )



### Additional colours



### Unique finishes



click to  
[Configure Quattro](#)

ASTM E84  
CLASS A

acoustics  
35 STC

UL LISTED US UL 962

CERTIFIED  
CARBON  
NEUTRAL  
product

CERTIFIED  
ENVIRONMENTALLY  
PREFERABLE PRODUCT  
GREENGUARD  
GREENGUARD  
GREENGUARD

## Available Add-ons for Quattro



### Video Conference Pod

- Universal screen bracket (on left side wall)
- Additional wall-integrated **power socket 110V + USB charging ports**
- Gaia movable laptop tables (height: 690mm/27.5")
- Vega low-back modular sofa (set)
- Air flow and lighting dimmer
- Colour collection sides

- Cotton exterior
- Dark Grey interior
- Black profiles



### Private Office

- Height-adjustable table (height: min 700mm, max 1150mm | table top: white; 1500×550mm)
- Swivel office chair (externally sourced)
- Additional wall-integrated **power socket 110V + USB charging ports**
- Air flow and lighting dimmer
- Colour collection sides

- Azurite exterior
- Dark Grey interior
- Black profiles



### Meeting Room

- Screen bracket on back glass (+VESA mount)
- Integrated table (height: 730mm/29" | table top: black; 1500×716mm)
- Additional **power sockets 2×110V + USB charging ports** (under the table)
- Vega low-back modular sofa (2 sets)

- Black exterior
- Dark Grey interior
- Black profiles



Virtual meetings



Focused work



Group meetings

# Get Inspired with Quattro



<sup>1</sup> Vega low-back modular sofa sets + laptop tables



<sup>2</sup> Vega low-back modular sofa set, integrated table + screens mount / Vega corner sofa configuration, Gaia mповable laptop tables + wall screen mount

scan for  
**Quattro AR**



# Finish Selections

## Interior Colours

**Standard wall and ceiling.**  
EchoFree acoustic paneling

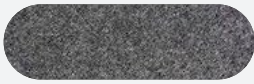

Dark Grey  
1897

**Standard floor.**  
Desso Essence carpet



Dark Grey  
9502

## Door frame

**Door hardware, handle and hinges.**



Black  
RAL 9005

## Exterior Side Colours

**Standard exterior finishes.**  
Painted sheet metal



White  
RAL 9003



Black  
RAL 9011

## Additional colours & finishes.

Colour collection sides



Cotton  
RAL 7044



Paprika  
RAL 2013



Opal  
RAL 220 40 15



Azurite  
RAL 5008



Marshmallow  
RAL 040 80 10



Storm Gray  
RAL 240 50 05



Myosotis  
RAL 4009



Frozen Blue  
RAL 250 70 10

Unique finishes

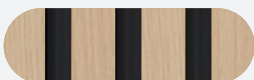

Slatted Oak



Whiteboard paint  
RAL 9003

## Modular Sofa Colours

**Standard fabric colours.**  
QUEST - Eco-friendly fabric from Camira.

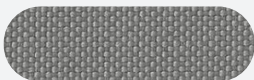

Light Grey  
QUE 02



Dark Grey  
QUE 04



Black  
QUE 01

## Additional fabric colours.

QUEST - Eco-friendly fabric from Camira.





Quality Is In The Details

CHATBOX



Single



Lights ▶

Energy-efficient LED lights and spot lights controlled by the presence detectors.

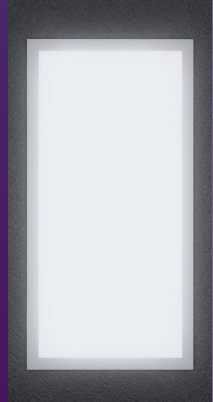

◀ Exterior

Painted sheet metal in standard black or white color (Colour collection sides available).



◀ Glass

4+4 / 6+6 mm laminated soundcontrol clear glass.



Hinges ▶

Door profile-to-glass hinge that seals the door perfectly.

Door Orientation

Right or left-handed orientation.

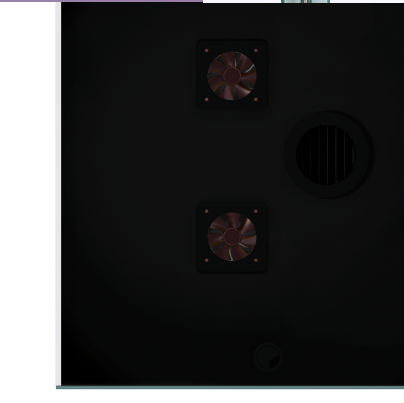

▲ Air Ventilation

Automated air circulation.



▲ Wall Power Outlet

2 x 110 V + USB + USB-C.

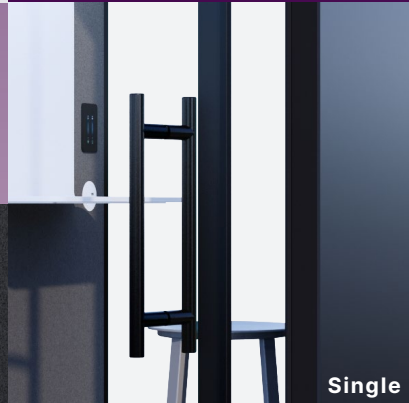

Single

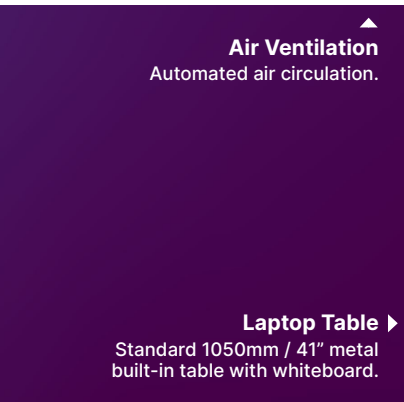

▶ Laptop Table

Standard 1050mm / 41" metal built-in table with whiteboard.



Single

▶ Integrated Power Outlet







110 V + USB + USB-C.



Single

## Available Add-ons







### Standard seating Free-standing or integrated seating for the most effective use of your booth.

	Product	Description / Notes **
	<p><b>Integrated stool</b></p>	<p><b>Built-in chair recommended for S1 / Single booths</b></p> <p><b>Seat diameter: 35cm / 14"</b> <b>Height: min 56cm; max 82cm</b></p> <p>** Built-in stool with adjustable leg; Black base and dark grey (Camira Quest - QUE04 Mussel) upholstered seat; Extra charges for non-standard fabric colours will apply.</p>
	<p><b>Revolving stool</b></p>	<p><b>360 degrees rotating seat with foot rest</b></p> <p><b>Height: Bar-height - 76cm / 30"</b></p> <p>** Available in black, grey, white and red powder-coated steel finish.</p>
	<p><b>Folding chair</b></p>	<p><b>Recommended for Hybrid pods or in combination with ADA kit</b></p> <p><b>Seat width: 50cm / 20"</b></p> <p>** Foldable jumpseat attached to the interior side module; Natural birch plywood construction and upholstered seat (textile: Camira Xtreme collection); Extra charges for upgraded finishes will apply.</p>
	<p><b>Powerchat chair</b></p>	<p><b>Fully upholstered swivel medium sized armchair.</b></p> <p>** Polished aluminum base; Additional charges for upgraded finishes will apply.</p>
	<p><b>Quiet work chair</b></p>	<p><b>Fully upholstered swivel armchair; height-adjustable; relaxing rocking mechanism</b></p> <p>** Polished aluminum five-star base with casters; Extra charges for upgraded finishes will apply.</p>
	<p><b>Powerchat set</b></p>	<p><b>2 Powerchat chairs + Powerchat table</b></p> <p>** Polished aluminum chair base + chrome table frame; Extra charges for upgraded finishes will apply.</p>

## Available Add-ons





### Modular sofas & sets

Modular seating for the most effective use of your booth.

	Product	Description / Notes **
	<p><b>Vega low-back sofa unit</b></p>	<p><b>Back-rest height: 77cm / 30"</b>  <b>Standard width : 113 × 62cm / 43 × 24"</b>  <b>(custom width: 62-150cm / 24 - 60")</b></p> <p>** Metal and wood frame with comfortable seats. Durable metal base, fixed seat and back cushions; Standard fabric colours - light grey, dark grey or black; Extra charges for non-standard fabric colours will apply.</p>
	<p><b>Vega low-back corner sofa unit</b></p>	<p><b>Back-rest height: 77cm / 30"</b>  <b>Standard width : 113 × 62cm / 43 × 24"</b>  <b>(custom width: 62-150cm / 24 - 60")</b></p> <p>** Metal and wood frame with comfortable seats. Durable metal base, fixed seat and back cushions; Standard fabric colours - light grey, dark grey or black; Extra charges for non-standard fabric colours will apply.</p>
	<p><b>Vega high-back sofa unit</b></p>	<p><b>Back-rest height: 128cm / 50"</b>  <b>Standard width : 113 × 62cm / 43 × 24"</b>  <b>(custom width: 62-150cm / 24 - 60")</b></p> <p>** Metal and wood frame with comfortable seats. Durable metal base, fixed seat and back cushions; Standard fabric colours - light grey, dark grey or black; Extra charges for non-standard fabric colours will apply.</p>
	<p><b>Vega high-back corner sofa unit</b></p>	<p><b>Back-rest height: 128cm / 50"</b>  <b>Standard width : 113 × 62cm / 43 × 24"</b>  <b>(custom width: 62-150cm / 24 - 60")</b></p> <p>** Metal and wood frame with comfortable seats. Durable metal base, fixed seat and back cushions; Standard fabric colours - light grey, dark grey or black; Extra charges for non-standard fabric colours will apply.</p>
	<p><b>Vega low-back sofa &amp; table set</b></p>	<p><b>Recommended for Space 2 / Duo booths</b></p> <p><b>2 low-back modular sofas + integrated table</b></p> <p>** Standard fabric colours - light grey, dark grey and black; Extra charges for non-standard fabric colours will apply.</p>
	<p><b>Vega high-back sofa &amp; table set</b></p>	<p><b>Recommended for Space 2 / Duo booths</b></p> <p><b>2 high-back modular sofas + integrated table</b></p> <p>** Standard fabric colours - light grey, dark grey and black; Extra charges for non-standard fabric colours will apply.</p>

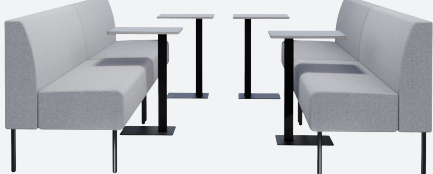



## Available Add-ons

### Modular sofa sets Modular seating for the most effective use of your booth.

	Product	Description / Notes **
	<p><b>S2 Sofa &amp; table set</b></p>	<p><b>Recommended for Space 2 / Duo booths</b></p> <p><b>2 low-back sofas + 2 laptop tables</b></p> <p>** Black side table + Standard fabric colours - light grey, dark grey and black; Extra charges for non-standard fabrics, optional colours or finishes will apply.</p>
	<p><b>S4 Sofa &amp; table set</b></p>	<p><b>Recommended for Space 4 / Space Max / Quattro booths</b></p> <p><b>4 low-back sofas + 4 laptop tables</b></p> <p>** Black side table + Standard fabric colours - light grey, dark grey and black; Extra charges for non-standard fabrics, optional colours or finishes will apply.</p>
	<p><b>S6 Sofa &amp; table set</b></p>	<p><b>Recommended for Space 6 booths</b></p> <p><b>6 high-back sofas + 6 laptop tables</b></p> <p>** Black side table + Standard fabric colours - light grey, dark grey and black; Extra charges for non-standard fabrics, optional colours or finishes will apply.</p>
	<p><b>S2 Sofa &amp; table set</b></p>	<p><b>Recommended for Space 2 / Duo booths</b></p> <p><b>2 high-back sofas + 2 laptop tables</b></p> <p>** Black side table + Standard fabric colours - light grey, dark grey and black; Extra charges for non-standard fabrics, optional colours or finishes will apply.</p>
	<p><b>S4 Sofa &amp; table set</b></p>	<p><b>Recommended for Space 4 / Space Max / Quattro booths</b></p> <p><b>4 high-back sofas + 4 laptop tables</b></p> <p>** Black side table + Standard fabric colours - light grey, dark grey and black; Extra charges for non-standard fabrics, optional colours or finishes will apply.</p>
	<p><b>S6 Sofa &amp; table set</b></p>	<p><b>Recommended for Space 6 booths</b></p> <p><b>6 high-back sofas + 6 laptop tables</b></p> <p>** Black side table + Standard fabric colours - light grey, dark grey and black; Extra charges for non-standard fabrics, optional colours or finishes will apply.</p>







## Available Add-ons

### Modular sofa sets Modular seating for the most effective use of your booth.

	Product	Description / Notes **
	<p><b>S4 Corner sofa set</b></p>	<p><b>Recommended for Space 4 booths</b></p> <p><b>3 custom-sized low-back modules</b></p> <p>** Standard fabric colours - light grey, dark grey and black; Extra charges for non-standard fabric colours will apply.</p>
	<p><b>S6 Corner sofa set</b></p>	<p><b>Recommended for Space 6 booths</b></p> <p><b>4 custom-sized low-back modules</b></p> <p>** Standard fabric colours - light grey, dark grey and black; Extra charges for non-standard fabric colours will apply.</p>
	<p><b>SMax Corner sofa set</b></p>	<p><b>Recommended for Space Max booths</b></p> <p><b>4 custom-sized low-back modules</b></p> <p>** Standard fabric colours - light grey, dark grey and black; Extra charges for non-standard fabric colours will apply.</p>
	<p><b>SMax Wrap-around sofa set</b></p>	<p><b>Recommended for Space Max booths</b></p> <p><b>5 custom-sized low-back modules</b></p> <p>** Standard fabric colours - light grey, dark grey and black; Extra charges for non-standard fabric colours will apply.</p>
	<p><b>SMax 2X Wrap-around sofa set</b></p>	<p><b>Recommended for Space Max 2X booths</b></p> <p><b>6 custom-sized low-back modules</b></p> <p>** Standard fabric colours - light grey, dark grey and black; Extra charges for non-standard fabric colours will apply.</p>

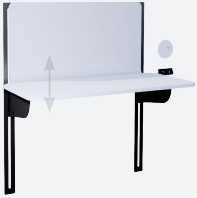

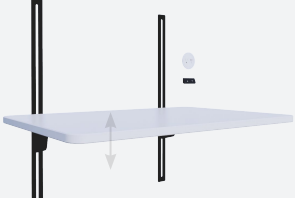



## Available Add-ons

### Integrated tables Integrated tables for the most effective use of your acoustic booths.

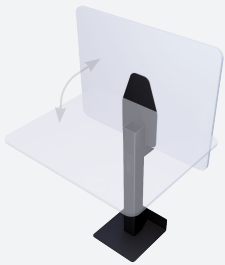
	Product	Description / Notes **
	<b>S1/Single built-in table</b>	<p><b>Recommended for Space 1 or Single booths</b>  <b>Height: Standard-105cm / 41"; Optional-73cm / 29"</b>  <b>Table top: 67 × 27 cm / 26 × 11"</b>            ** White laminated table top with metal magnetic board; Comes with one wall power socket + USB-A + USB-C.</p>
	<b>S1/Single built-in whiteboard table</b>  <b>+\$800 CAD*</b> <b>*Fenix NTM table top</b>	<p><b>Recommended for Space 1 or Single booths</b>  <b>Height: Standard-105cm / 41"; Optional-73cm / 29"</b>  <b>Table top: 67 × 27 cm / 26 × 11"</b>  <b>Whiteboard: 60 × 75 cm / 23 × 30"</b>            ** White laminated table top; Tall metal magnetic board with one table-integrated or wall power socket + USB-A + USB-C connections.</p>
	<b>Height-adjustable table</b>	<p><b>Height: min 70cm / 28", max 115cm / 45"</b>  <b>Table top: 67 × 27 cm / 26 × 11"</b>            ** White laminated MDF table top; Lifting mechanism located inside the wall module.</p>
	<b>S1.5 Fixed-height table</b>	<p><b>Recommended for Space 1.5 booth</b>  <b>Height: min 74cm / 29"</b>  <b>Table top: 80 × 55 cm / 31 × 22"</b>  <b>Opt. a /</b> White (antibacterial) laminated MDF table top;  <b>Opt. b /</b> White or black Fenix NTM table top with beveled plywood edge; (on request)            ** Built-in table; Comes with one wall power socket + USB-A + USB-C connections.</p>
	<b>S1.5 height-adjustable table</b>	<p><b>Recommended for Space 1.5 booth</b>  <b>Height: min 72cm / 28", max 115cm / 45"</b>  <b>Table top: 80 × 55 cm / 31 × 22"</b>  <b>Opt. a /</b> White (antibacterial) laminated table top;  <b>Opt. b /</b> White or black Fenix NTM table top with beveled plywood edge; (on request)</p>
	<b>Integrated S2 table</b>	<p><b>Recommended for Space 2 booths (or bigger)</b>  <b>Height: 73cm / 29"</b>  <b>Table top: 60 × 74cm / 24 × 29"</b>  <b>Opt. a /</b> White (antibacterial) laminated table top;  <b>Opt. b /</b> White or black Fenix NTM table top with beveled plywood edge; (on request)            ** Black metal base hidden under the carpet; Power outlets not included - integrated power socket option.</p>
	<b>Integrated S2 table with swivel mount</b>  <b>+\$800 CAD*</b> <b>*Fenix NTM table top</b>	<p><b>Recommended for Space 2 booths</b>  <b>VESA 100 × 100 and 200 × 200 mounting Bracket available only with integrated table</b>            ** Standard S2 table with swivel bracket for 27" screen (screen not included); Cable tray under the table; Includes power outlet (2 × 110V + USB-A + USB-C) under the table.</p>



## Available Add-ons

### Integrated tables Integrated tables for the most effective use of your acoustic booths.



	Product	Description / Notes **
	<b>Foldable Hybrid table</b>	<p><b>Recommended for Space 2 booths (or bigger)</b></p> <p><b>Height: 73cm / 29"</b>  <b>Table top: 58 × 74cm / 24 × 29"</b></p> <p>** Built-in table; white or black Fenix NTM (antibacterial) table top with plywood edge; Black metal base; Gas-spring and power outlet integrated inside leg column.</p>
	<b>Built-in Height-adjustable table</b>	<p><b>Recommended for Space 2 booths (or bigger)</b></p> <p><b>Height: min 70cm / 28", max 115cm / 45"</b>  <b>Table top: 110 × 55cm / 43 × 22"</b></p> <p><b>Opt. a /</b> White (antibacterial) laminated table top;  <b>Opt. b /</b> White or black Fenix NTM table top with beveled plywood edge;</p> <p>** Black metal base hidden under the carpet; Includes wall integrated power outlet (2 × 110V + USB-A + USB-C); Electrically adjustable with buttons on the edge of the table top.</p>
	<b>Built-in Height-adjustable table</b>	<p><b>Recommended for Space 2.5 booths (or bigger)</b></p> <p><b>Height: min 70cm / 28", max 115cm / 45"</b>  <b>Table top: 150 × 55cm / 59 × 22"</b></p> <p><b>Opt. a /</b> White (antibacterial) laminated table top;  <b>Opt. b /</b> White or black Fenix NTM table top with beveled plywood edge;</p> <p>** Black metal base hidden under the carpet; Includes wall integrated power outlet (2 × 110V + USB-A + USB-C); Electrically adjustable with buttons on the edge of the table top.</p>
	<b>Integrated S4 table</b>	<p><b>Recommended for Space 2 booths (or bigger)</b></p> <p><b>Height: 73cm / 29"</b>  <b>Table top: 182 × 74cm / 72 × 29"</b></p> <p><b>Opt. a /</b> White (antibacterial) laminated table top;  <b>Opt. b /</b> White or black Fenix NTM table top with beveled plywood edge; (on request)</p> <p>** Black metal base hidden under the carpet; Power outlets not included - integrated power socket option</p>
	<b>Integrated S4 table with swivel mount</b>  <b>+\$800 CAD*</b> <b>*Fenix NTM table top</b>	<p><b>Recommended for Space 4 booths</b></p> <p><b>VESA 100 × 100 and 200 × 200 mounting</b>  <b>Bracket available only with integrated table</b></p> <p>** Standard S4 table with swivel bracket for up to 40" screen (screen not included); Cable tray under the table; Includes power outlet (2 × 110V + USB-A + USB-C) under the table.</p>
	<b>Integrated SMax table</b>	<p><b>Recommended for Space Max booths (or bigger)</b></p> <p><b>Height: 73cm / 29"</b></p> <p><b>Table top:</b> Space Max - 200 × 90cm / 79 × 35"  Space Max 2X (double size) - 400 × 90cm / 158 × 35"</p> <p>** Built-in table; white or black Fenix table top with beveled plywood edge, white or black metal base; Includes cable tray; Power outlets not included - wall power socket option available.</p>

## Available Add-ons

### Integrated tables Integrated tables for the most effective use of your acoustic booths.

	Product	Description / Notes **
	<b>Integrated Duo table</b>	<p><b>Recommended for Duo booths (or bigger)</b></p> <p><b>Height: 73cm / 29"</b> <b>Table top: 50 × 72cm / 20 × 28"</b></p> <p>** Built-in table; white or black laminated table top (antibacterial); Black metal base hidden under the carpet; Power outlets not included - integrated power socket option available.</p>
	<b>Height-adjustable Duo table</b>	<p><b>Recommended for Duo booths (or bigger)</b></p> <p><b>Height: min 70cm / 28", max 115cm / 45"</b> <b>Table top: 55 × 90cm / 22 × 35"</b></p> <p>** Built-in table; White or black laminated table top; Black metal base hidden under the carpet; Includes wall integrated power outlet (2 × 110V + USB + USB-C).</p>
	<b>Integrated Quattro table</b>	<p><b>Recommended for Quattro booths</b></p> <p><b>Height: 73cm / 29"</b> <b>Table top: 150 × 72cm / 59 × 28"</b></p> <p>** Built-in table; White or black laminated table top (antibacterial); Black metal base hidden under the carpet; Power outlets not included - integrated power socket option available.</p>

### Standard tables Work tables for the most effective use of your booth.

	Product	Description / Notes **
	<b>Gaia table</b>	<p><b>Height: 69cm / 27"</b> <b>Table top: 33 × 50 cm / 13 × 20"</b></p> <p>** White / black Fenix NTM laminate table top with beveled plywood edge; Powder-coated metal base (black); additional charges for upgraded finishes will apply.</p>
	<b>Powerchat table</b>	<p><b>Height: 73cm / 29"</b> <b>Table top diameter: 75cm / 30"</b></p> <p>** White HPL table top with 4-star aluminum base (polished) with plastic gliders; Additional charges for upgraded finishes will apply.</p>
	<b>Vertical table</b>	<p><b>Height: 109cm / 43"</b> <b>Table top diameter: 75cm / 30"</b></p> <p>** White HPL table top with 4-star aluminum base (polished) with plastic gliders; Additional charges for upgraded finishes will apply.</p>







## Available Add-ons

### Wall mounted upgrades

	Product	Description / Notes **
	<b>Whiteboard</b>	<p><b>Recommended for Space 4 booths (or bigger)</b></p> <p><b>127 × 71cm / 50 × 28"</b></p> <p>** Magnetic dry-erase board; Glass high-gloss surface.</p>
	<b>Whiteboard</b>	<p><b>Recommended for Space 4 booths (or bigger)</b></p> <p><b>200 × 100cm / 79 × 39"</b></p> <p>** Magnetic dry-erase board; Glass high-gloss surface. Optional whiteboard-mounted V/C ready screen bracket available.</p>
	<b>Whiteboard</b>	<p><b>Recommended for Duo booths</b></p> <p><b>60 × 90cm / 24 × 35"</b></p> <p>** White magnetic laminate surface.</p>
	<b>Extra face lights</b>	<p><b>Recommended for Space 1 booths</b></p> <p><b>Pair with default S1 built-in / adjustable tables.</b></p> <p>** Extra face lights for improved video calls.</p>
	<b>Coat / Bag hook</b>	<p><b>Wall integrated retractable hook for coat / bag.</b></p> <p>** Black or white with plywood edge.</p>
	<b>Storage unit</b>	<p><b>Recommended for Space 2 booths (or bigger)</b></p> <p><b>850 × 400 × 290 cm / 33.5 × 16 × 11.5"</b></p> <p>** Wall-integrated storage unit; White or black Fenix NTM laminate with plywood edge; Contains shelves and 2 soft closing drawers.</p>

## Available Add-ons

### Wall mounted upgrades Integrated screen brackets.

	Product	Description / Notes **
	<p><b>V/C readiness</b></p>	<p><b>Recommended for Space 1 booths</b></p> <p><b>VESA 100 × 100 and 200 × 200 mounting</b></p> <p>** Universal bracket for 24" screen (screen not included); Wiring located inside the wall module; HDMI connection extra face lights for improved video calls and additional power outlet (located behind the screen) included.</p>
	<p><b>V/C readiness</b></p>	<p><b>Recommended for Single booths</b></p> <p><b>VESA 100 × 100 and 200 × 200 mounting</b></p> <p>** Universal bracket for 24" screen (screen not included); Wiring located inside the wall module.</p>
	<p><b>Wall mounted screen bracket</b></p>	<p><b>Recommended for Space 2 / Duo booths (or bigger)</b></p> <p><b>VESA 100 × 100 and 200 × 200 mounting</b></p> <p>** Universal bracket located on the side wall for up to 43" screen (screen not included); 2 × power outlet on wall module H=140cm; Bracket location will be specified when ordering (left or right side wall).</p>
	<p><b>Wall mounted swivel screen bracket</b></p>	<p><b>Recommended for Space 2 / Duo booths (or bigger)</b></p> <p><b>VESA 100 × 100 and 200 × 200 mounting</b></p> <p>** Universal bracket located on the side wall for up to 43" screen (screen not included); 2 × power outlet on wall module H=140cm; Bracket location will be specified when ordering (left or right side wall).</p>
	<p><b>Glass screen bracket</b></p>	<p><b>Recommended for Space 2 /Quattro booths (or bigger)</b></p> <p><b>VESA 100 × 100 and 200 × 200 mounting</b></p> <p>** Universal bracket located on the back glass for up to 40" screen (screen not included).</p>





## Available Add-ons

### Built-in upgrades Connections and door hardware.

	Product	Description / Notes **
	<b>Table power outlet</b>	<p><b>2 × 110V + USB-A + USB-C</b>  <b>Available only with integrated table.</b></p> <p>** Additional power outlet placed under the table; Cables routed through the base.</p>
	<b>Table / Sofa power outlet</b>	<p><b>3 × 110V + 2 × USB-A</b>  <b>Available only with integrated table.</b></p> <p>** Additional power outlet placed on the table or under sofa; Cables routed through the base.</p>
	<b>Wall integrated power outlet / connection</b>	<p><b>2 × 110V + connections (USB-A / USB-C / LAN port)</b></p> <p>** Additional power outlet and network access via Ethernet connection integrated into a wall panel; Position and install height: custom specified; Additional power and data options available upon request for extra cost (LAN, USB-A, USB-C).</p>
	<b>LAN connection</b>	<p><b>LAN cable</b></p> <p>** Network access via Ethernet connection; LAN port integrated in the floor outlet.</p> <p><b>LAN / RJ45 / HDMI connections</b></p> <p>** Additional power and data options available upon request (LAN, RJ45, HDMI, USB-C).</p>
	<b>Door operator</b>	<p><b>Automatic door opener / closer</b></p> <p>** Push version; Swing door operator and push-to-open buttons for a barrier-free access (wave-to-open buttons available for extra fee).</p>
	<b>Self-closing hinges</b>	<p><b>Set (per door)</b></p> <p>** Available in anodized aluminum and black finishing.</p>
	<b>Central lock</b>	<p><b>With a key and knob</b></p> <p>** Prepared for europrofile cylinder and lever handle.</p>
	<b>Antibacterial door handle</b>	

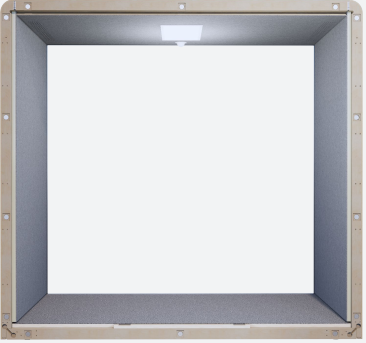
## Available Add-ons

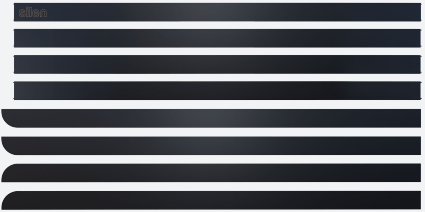
### Modularity upgrades Extension kits and hardware.

	Product	Description / Notes **
	<b>Standard extension module</b>	<p><b>For Space 2 / 4 and Max booths</b></p> <p>** An extension module to create S4 with existing S2 pod or to create S6 with existing S4 pod; create SMax 2X by adding another Max module to existing SMax; Extension module comes without glass and covering trims.</p> <p>Half-size (60cm deep) module to create S2.5 or S4.5 available.</p>
	<b>Low floor extension module</b>	<p><b>For Space 2 Hybrid booths</b></p> <p>** An extension module to create Space 4 Hybrid with existing Space 2 Hybrid; Comes without glass and covering trims.</p> <p>Half-size (60cm deep) module to create Space 2.5 Hybrid available.</p>
	<b>Connection kit</b>	<p><b>For Space 2 / 4 booths</b></p> <p>** A kit to connect two Space 2 rooms into one Space 4; Includes 8 x connecting rods and 4x interior trim pieces.</p>
	<b>Extra cover trims set</b>	<p><b>For Space 1 booths</b></p> <p>** Easily replaceable magnetic trims in 3 standard and 22 additional exterior finishes.</p>
	<b>Extra cover trims set</b>	<p><b>For Space 2/4/6/Max booths</b></p> <p>** Easily replaceable magnetic trims in 3 standard and 22 additional exterior finishes.</p>
	<b>Second door option</b>	<p><b>For Space 4 / 4.5 / 6 / Max / Max 2X booths</b></p> <p><b>Additional door frame, glass and hardware</b></p> <p>** Recommended to use for easy access from both sides of larger acoustic booths; available in anodized aluminum, black and white (door frame only) finishes.</p>
	<b>Side door option</b>	<p><b>For Space 2 / 2.5 / 4 / 4.5 / 6 / Max / Max 2X booths</b></p> <p><b>Standard front door model with custom - side position (left or right)</b></p> <p>** Recommended to use for easier door access with specific interior furniture setups.</p>

## Available Add-ons

	Product	Description / Notes **
	<b>Frosted film between glasses</b>	<b>Front / Rear privacy glass</b> ** Frosted film installed between two pieces of laminated sound control glass.
	<b>Frosted film on glass</b>	<b>Front / Rear privacy glass</b> ** Frosted film installed on the glass (inside or outside); The exterior privacy film is prone to scratches.
	<b>Sprinkler prep</b>	** Knockout with a tube inside the ceiling module for housing a sprinkler; Does not include a spinkler.
	<b>Seismic kit</b>	** Brackets to mount the floor module to the existing floor with anchor bolts.
	<b>Scheduler kit</b>	** Wiring and connection prep for digital scheduling panel; Clean setup with cabling integrated in a door frame (scheduler not included).
	<b>Dimmer</b>	<b>Airflow and lighting dimmer and on/off switch</b> ** Optional airflow / light intensity control.
	<b>Occupancy indicator light</b>	** Located on one side of the pod's roof; 1pc.

# References

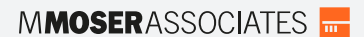
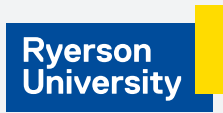

## Explore

### **Wallenium Partition Walls Inc.**

7-1238 Homer Street  
Vancouver, BC  
V6Z 2Y5  
CANADA

### **Links for more information and content:**

wallenium.ca  
wallenium.ca/chatbox/  
instagram.com/wallenium/

### **Online configurator:**

design.wallenium.ca

### **Virtual Design Centre:**

wallenium.ca/designcentre/  
wallenium.ca/designcentre/chatbox/

### **Augmented reality:**

click or scan for AR preview



Silen AR

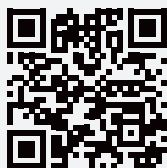

Chatbox AR

